



DRAGONFLY

INSTALLATION & OPERATION INSTRUCTIONS

English (EN)

Date: 01-2016

Document number: 81358-3

© 2016 Raymarine UK Limited



Raymarine[®]
BY **FLIR**

Document and software changes

The following tables describe the main changes that have been made since the last release of both the product software and this document.

- **Applicable software version:** Dragonfly® LightHouse™ II — Release 12
- **Applicable documents:** 81358–3
- **Applicable products:** Dragonfly-4 DV / Dragonfly-4 DVS / Dragonfly-4 Pro / Dragonfly-5 DVS / Dragonfly-5 M / Dragonfly-5 Pro / Dragonfly-7 Pro (Does not apply to the Wi-Fish™ product.)

New features

Description	Applicable application	Applicable chapter(s) or section(s)
Added support for Dragonfly-7 Pro	N/A	N/A
Superior downrigger sonar performance.	Sonar / DownVision	N/A
Improved bottom tracking capabilities.	Sonar / DownVision	N/A

Trademark and patents notice

Raymarine, Tacktick, Clear Pulse, Truzoom, HSB, SeaTalk, SeaTalk^{hs}, SeaTalk^{ng}, Micronet, Raytech, Gear Up, Marine Shield, Seahawk, Autohelm, Automagic, and Visionality are registered or claimed trademarks of Raymarine Belgium.

FLIR, DownVision, SideVision, Dragonfly, Quantum, Instalert, Infrared Everywhere, and The World's Sixth Sense are registered or claimed trademarks of FLIR Systems, Inc.

All other trademarks, trade names, or company names referenced herein are used for identification only and are the property of their respective owners.

This product is protected by patents, design patents, patents pending, or design patents pending.

Fair Use Statement

You may print no more than three copies of this manual for your own use. You may not make any further copies or distribute or use the manual in any other way including without limitation exploiting the manual commercially or giving or selling copies to third parties.

Software updates

Important: Check the Raymarine website for the latest software releases for your product.

www.raymarine.com/software

Product handbooks

The latest versions of all English and translated handbooks are available to download in PDF format from the website www.raymarine.com. Please check the website to ensure you have the latest handbooks.

Copyright ©2016 Raymarine UK Ltd. All rights reserved.

Contents

Chapter 1 Important information.....	7	5.1 General cabling guidance	36
TFT Displays	8	5.2 Connections overview	36
Water ingress	8	5.3 Cable connection –DV, DVS, Pro and Wi-Fish™	38
Disclaimers	8	5.4 Connecting the power cable - 5 M	38
Memory cards and chart cards	8	5.5 Extension cable connection	41
EMC installation guidelines	8	Chapter 6 Wi-Fish™	43
RF exposure	9	6.1 Wi-Fish controls	44
FCC.....	9	6.2 Switching the unit on and off	44
Compliance Statement (Part 15.19)	9	6.3 Wi-Fish™ mobile app	45
FCC Interference Statement (Part 15.105 (b))	9	6.4 Wi-Fish™ initial set up	46
Industry Canada	9	6.5 Depth Offset	46
Industry Canada (Français)	9	6.6 Switching on the simulator — Wi-Fish™ app.....	47
Japanese approvals.....	10	6.7 Opening the MicroSD card reader cover	47
Third party software license agreements	10	Chapter 7 Getting started	49
Declaration of conformity.....	10	7.1 Controls — DV, DVS, Pro and M	50
Pixel defect policy	10	7.2 Switching the unit on and off	50
Warranty policy.....	10	7.3 Initial set up procedures.....	51
Warranty registration.....	10	7.4 Satellite-based navigation.....	52
Product disposal.....	10	7.5 Checking the sonar application	53
IMO and SOLAS.....	10	7.6 Checking the DownVision™ application	54
Technical accuracy	10	7.7 Shortcuts page.....	54
Chapter 2 Document and product information.....	13	7.8 Applications	55
2.1 Document information	14	7.9 View switcher.....	56
2.2 Product overview	16	7.10 Memory cards and chart cards	57
2.3 CHIRP DownVision™ overview.....	17	7.11 Learning resources.....	58
2.4 CHIRP Sonar overview.....	17	Chapter 8 Fishfinder applications.....	59
Chapter 3 Planning the installation	19	8.1 DownVision™ application overview.....	60
3.1 Installation checklist	20	8.2 Sonar application overview	60
3.2 Parts supplied – DV, DVS, and Pro variants	20	8.3 Fishfinder applications' features	62
3.3 Parts supplied – 5 M.....	21	8.4 Fishfinder applications' controls	62
3.4 Parts supplied — Wi-Fish™	21	8.5 Zoom	63
3.5 DownVision™ transducer compatibility.....	22	8.6 Range	64
3.6 Tools required for installation — Dragonfly® DV / DVS / Pro / Wi-Fish™	23	8.7 Scrolling	64
3.7 Tools required for installation — Dragonfly-5 M	23	8.8 A-Scope mode	65
3.8 Software updates	24	8.9 Display Options.....	65
3.9 Warnings and cautions	24	8.10 Colors	66
3.10 Selecting a location for the transducer	25	8.11 Sensitivity adjustments	67
3.11 Cable routing.....	26	8.12 DV System settings menu options	68
3.12 Selecting a location for the display.....	26	Chapter 9 Chart application.....	69
3.13 Installation process.....	28	9.1 Chart application overview	70
Chapter 4 Mounting.....	29	9.2 Electronic charts overview	71
4.1 Mounting the transom mount bracket.....	30	9.3 Chart application controls	73
4.2 Mounting the transducer	30	9.4 Waypoints overview	74
4.3 Mounting the unit	31	9.5 Tracks	81
4.4 Testing and adjusting the transducer	32	9.6 Import and Export	83
4.5 Finalizing the transducer mounting	33	9.7 Waypoints and tracks storage capacity	84
Chapter 5 Cables and connections.....	35	9.8 Navigation	84
		9.9 Chart settings menu — cartography compatibility	85

9.10 Chart selection	86
9.11 Chart Detail	86
9.12 High resolution bathymetry	87
9.13 Chart orientation	87
9.14 Text and Symbol size	88
9.15 Boat position	89
9.16 Community layer	89
9.17 Sonar logging	90
9.18 COG Vector	90
9.19 Deep Water	91
9.20 Chart objects	91
9.21 5 M System settings menu	92
Chapter 10 Mobile applications.....	93
10.1 Wi-Fish™ mobile app	94
10.2 Connecting Wi-Fi — Pro displays	94
Chapter 11 Tools & Settings	95
11.1 System Settings menu	96
11.2 Alarms	102
11.3 Backup and reset	105
11.4 Wi-Fi Settings.....	107
Chapter 12 Maintenance	109
12.1 Service and maintenance	110
12.2 Product cleaning	110
12.3 Transducer cleaning	111
Chapter 13 Troubleshooting	113
13.1 Troubleshooting	114
13.2 Power up troubleshooting	115
13.3 GPS troubleshooting	116
13.4 Sonar / DownVision troubleshooting	117
13.5 Wi-Fi troubleshooting.....	119
13.6 Miscellaneous troubleshooting	121
Chapter 14 Technical support	123
14.1 Raymarine product support and servicing.....	124
14.2 Learning resources.....	125
Chapter 15 Technical specification.....	127
15.1 Technical specification — Dragonfly-4.....	128
15.2 Technical specification — Dragonfly-5.....	129
15.3 Technical specification — Dragonfly-7.....	130
15.4 Technical specification — Wi-Fish™	131
15.5 Technical specification — CPT-DV and CPT-DVS	131
Chapter 16 Spares and accessories	133
16.1 Spares & Accessories	134

Chapter 1: Important information



Warning: Product installation and operation

- This product must be installed and operated in accordance with the instructions provided. Failure to do so could result in personal injury, damage to your vessel and/or poor product performance.
- Raymarine recommends certified installation by a Raymarine approved installer. A certified installation qualifies for enhanced product warranty benefits. Contact your Raymarine dealer for further details, and refer to the separate warranty document packed with your product.



Warning: Ensure safe navigation

This product is intended only as an aid to navigation and must never be used in preference to sound navigational judgment. Only official government charts and notices to mariners contain all the current information needed for safe navigation, and the captain is responsible for their prudent use. It is the user's responsibility to use official government charts, notices to mariners, caution and proper navigational skill when operating this or any other Raymarine product.



Warning: Potential ignition source

This product is NOT approved for use in hazardous/flammable atmospheres. Do NOT install in a hazardous/flammable atmosphere (such as in an engine room or near fuel tanks).



Warning: 12 Volt dc only

This product must only be connected to a 12 volt dc power source.



Warning: High voltages

This product may contain high voltages. Do NOT remove any covers or otherwise attempt to access internal components, unless specifically instructed in the documentation provided.



Warning: Power supply voltage

Connecting this product to a voltage supply greater than the specified maximum rating may cause permanent damage to the unit. Refer to the *Technical specification* section for voltage rating.



Warning: Product grounding

Before applying power to this product, ensure it has been correctly grounded, in accordance with the instructions provided.



Warning: Switch off power supply

Ensure the vessel's power supply is switched OFF before starting to install this product. Do NOT connect or disconnect equipment with the power switched on, unless instructed in this document.



Warning: FCC Warning (Part 15.21)

Changes or modifications to this equipment not expressly approved in writing by Raymarine Incorporated could violate compliance with FCC rules and void the user's authority to operate the equipment.

Caution: Service and maintenance

This product contains no user serviceable components. Please refer all maintenance and repair to authorized Raymarine dealers. Unauthorized repair may affect your warranty.

Caution: Transducer cable

- Do NOT cut, shorten, or splice the transducer cable.
- Do NOT remove the connector.

If the cable is cut, it cannot be repaired. Cutting the cable will also void the warranty.

Caution: Power supply protection

When installing this product ensure the power source is adequately protected by means of a suitably-rated fuse or automatic circuit breaker.

Caution: Care of chart and memory cards

To avoid irreparable damage to and / or loss of data from chart and memory cards:

- DO NOT save data or files to a card containing cartography as the charts may be overwritten.
- Ensure that chart and memory cards are fitted the correct way around. DO NOT try to force a card into position.
- DO NOT use a metallic instrument such as a screwdriver or pliers to insert or remove a chart or memory card.

Caution: Ensure card reader door is securely closed

To prevent water ingress and consequent damage to the product, ensure that the card reader door is firmly closed.

Caution: Product cleaning

When cleaning products:

- If your product includes a display screen, do NOT wipe the screen with a dry cloth, as this could scratch the screen coating.
- Do NOT use abrasive, or acid or ammonia based products.
- Do NOT use a jet wash.

This product uses digital chart data, and electronic information from the Global Positioning System (GPS) which may contain errors. Raymarine does not warrant the accuracy of such information and you are advised that errors in such information may cause the product to malfunction. Raymarine is not responsible for damages or injuries caused by your use or inability to use the product, by the interaction of the product with products manufactured by others, or by errors in chart data or information utilized by the product and supplied by third parties.

Memory cards and chart cards

MicroSD memory cards can be used to back up / archive data (e.g. Waypoint, and Tracks). Once data is backed up to a memory card old data can be deleted from the system, creating capacity for new data. The archived data can be retrieved at any time. Chart cards provide additional or upgraded cartography.

It is recommended that your data is backed up to a memory card on a regular basis. Do NOT save data to a memory card containing cartography.

Compatible cards

The following types of MicroSD cards are compatible with your display:

- Micro Secure Digital Standard-Capacity (MicroSDSC)
- Micro Secure Digital High-Capacity (MicroSDHC)

Note:

- The maximum supported memory card capacity is 32 GB.
- MicroSD cards must be formatted to use either the FAT or FAT 32 file system format to enable use with your MFD.

TFT Displays

The colors of the display may seem to vary when viewed against a colored background or in colored light. This is a perfectly normal effect that can be seen with all color Thin Film Transistor (TFT) displays.

Water ingress

Water ingress disclaimer

Although the waterproof rating capacity of this product meets the stated IPX standard (refer to the product's *Technical Specification*), water intrusion and subsequent equipment failure may occur if the product is subjected to commercial high-pressure washing. Raymarine will not warrant products subjected to high-pressure washing.

Disclaimers

This product (including the electronic charts) is intended to be used only as an aid to navigation. It is designed to facilitate use of official government charts, not replace them. Only official government charts and notices to mariners contain all the current information needed for safe navigation, and the captain is responsible for their prudent use. It is the user's responsibility to use official government charts, notices to mariners, caution and proper navigational skill when operating this or any other Raymarine product. This product supports electronic charts provided by third party data suppliers which may be embedded or stored on memory card. Use of such charts is subject to the supplier's End-User Licence Agreement included in the documentation for this product or supplied with the memory card (as applicable).

Raymarine does not warrant that this product is error-free or that it is compatible with products manufactured by any person or entity other than Raymarine.

Speed class rating

For best performance it is recommended that you use Class 10 or UHS (Ultra High Speed) class memory cards.

Chart cards

Your product is pre-loaded with electronic charts (worldwide base map). If you wish to use different chart data, you can insert compatible chart cards into the unit's memory card reader.

Use branded chart cards and memory cards

When archiving data or creating an electronic chart card, Raymarine recommends the use of quality branded memory cards. Some brands of memory card may not work in your unit. Please contact customer support for a list of recommended cards.

EMC installation guidelines

Raymarine equipment and accessories conform to the appropriate Electromagnetic Compatibility (EMC) regulations, to minimize electromagnetic interference

between equipment and minimize the effect such interference could have on the performance of your system

Correct installation is required to ensure that EMC performance is not compromised.

Note: In areas of extreme EMC interference, some slight interference may be noticed on the product. Where this occurs the product and the source of the interference should be separated by a greater distance.

For **optimum** EMC performance we recommend that wherever possible:

- Raymarine equipment and cables connected to it are:
 - At least 1 m (3 ft) from any equipment transmitting or cables carrying radio signals e.g. VHF radios, cables and antennas. In the case of SSB radios, the distance should be increased to 7 ft (2 m).
 - More than 2 m (7 ft) from the path of a radar beam. A radar beam can normally be assumed to spread 20 degrees above and below the radiating element.
- The product is supplied from a separate battery from that used for engine start. This is important to prevent erratic behavior and data loss which can occur if the engine start does not have a separate battery.
- Raymarine specified cables are used.
- Cables are not cut or extended, unless doing so is detailed in the installation manual.

Note: Where constraints on the installation prevent any of the above recommendations, always ensure the maximum possible separation between different items of electrical equipment, to provide the best conditions for EMC performance throughout the installation

RF exposure

This equipment complies with FCC / IC RF exposure limits for general population / uncontrolled exposure. The wireless LAN / Bluetooth antenna is mounted behind the front facia of the display. This equipment should be installed and operated with a minimum distance of 1 cm (0.39 in) between the device and the body. This transmitter must not be co-located or operating in conjunction with any other antenna or transmitter, except in accordance with FCC multi-transmitter product procedures.

FCC

Compliance Statement (Part 15.19)

This device complies with Part 15 of the FCC Rules. Operation is subject to the following two conditions:

1. This device may not cause harmful interference.

2. This device must accept any interference received, including interference that may cause undesired operation.

FCC Interference Statement (Part 15.105 (b))

This equipment has been tested and found to comply with the limits for a Class B digital device, pursuant to Part 15 of the FCC Rules.

These limits are designed to provide reasonable protection against harmful interference in a residential installation. This equipment generates, uses, and can radiate radio frequency energy and, if not installed and used in accordance with the instructions, may cause harmful interference to radio communications. However, there is no guarantee that interference will not occur in a particular installation. If this equipment does cause harmful interference to radio or television reception, which can be determined by turning the equipment off and on, the user is encouraged to try to correct the interference by one of the following measures:

1. Reorient or relocate the receiving antenna.
2. Increase the separation between the equipment and receiver.
3. Connect the equipment into an outlet on a circuit different from that to which the receiver is connected.
4. Consult the dealer or an experienced radio / TV technician for help.

Industry Canada

This device complies with Industry Canada License-exempt RSS standard(s).

Operation is subject to the following two conditions:

1. This device may not cause interference; and
2. This device must accept any interference, including interference that may cause undesired operation of the device.

This Class B digital apparatus complies with Canadian ICES-003.

Industry Canada (Français)

Cet appareil est conforme aux normes d'exemption de licence RSS d'Industry Canada.

Son fonctionnement est soumis aux deux conditions suivantes:

1. cet appareil ne doit pas causer d'interférence, et
2. cet appareil doit accepter toute interférence, notamment les interférences qui peuvent affecter son fonctionnement.

Cet appareil numérique de la classe B est conforme à la norme NMB-003 du Canada.

Japanese approvals

In the frequency band used for this device, campus radio stations (radio stations that require a license) and specified low power radio stations (radio stations that do not require license) for mobile identification and amateur radio stations (radio stations that require license) used in industries such as microwave ovens, scientific, medical equipment devices and production line of other factories are also being operated.

1. Before using this device, please make sure that campus radio stations and specified low power radio stations for mobile identification and amateur radio stations are not being operated nearby.
2. In case there is any case of harmful interference to campus radio stations for mobile identification caused by this device, please immediately change the frequency used or stop the transmission of radio waves and then consult about the measures to avoid interference (for example, the installation of partitions) through the contact information below.
3. Besides, when in trouble, such as when there is any case of harmful interference to specified low power radio stations for mobile identification or amateur radio stations caused by this device, please consult through the following contact information.

Contact information: Please contact your local authorized Raymarine dealer.

Third party software license agreements

This product is subject to certain third party software license agreements as listed below:

- GNU — LGPL/GPL
- JPEG libraries
- OpenSSL
- FreeType

The license agreements for the above can be found on the website www.raymarine.com and on the accompanying documentation CD if supplied.

Declaration of conformity

Raymarine UK Ltd. declares that this product is compliant with the essential requirements of R&TTE directive 1999/5/EC.

The original Declaration of Conformity certificate may be viewed on the relevant product page at www.raymarine.com.

Pixel defect policy

In common with all TFT units, the screen may exhibit a few wrongly-illuminated (“dead”) pixels. These may appear as black pixels in a light area of the screen or as colored pixels in black areas.

If your display exhibits MORE than the number of wrongly-illuminated pixels allowed (refer to the product *technical specification* for details), please contact your local Raymarine service center for further advice.

Warranty policy

Your product is warranted to be free from defects in materials and workmanship for a period of 1 year from the date of first purchase of the product or, if installed on a new boat, the date of first boat delivery to the Original Customer (please retain proof of purchase in case you need to claim).

The full details of the Limited Warranty Policy and registration process are available online at: www.raymarine.com/warranty-dragonfly.

If you do not have access to the Internet, please phone the relevant number below to obtain warranty policy information:

In the USA:

- **Tel:** +1 603 324 7900
- **Toll Free:** +1 800 539 5539

In the UK, Europe, the Middle East, or Far East:

- **Tel:** +44 (0)13 2924 6777

Warranty registration

To register your Raymarine product ownership, please visit www.raymarine.com and register online.

It is important that you register your product to receive full warranty benefits. Your unit package includes a bar code label indicating the serial number of the unit. You will need this serial number when registering your product online. You should retain the label for future reference.

Product disposal

Dispose of this product in accordance with the WEEE Directive.



■ The Waste Electrical and Electronic Equipment (WEEE) Directive requires the recycling of waste electrical and electronic equipment.

IMO and SOLAS

The equipment described within this document is intended for use on leisure marine boats and workboats NOT covered by International Maritime Organization (IMO) and Safety of Life at Sea (SOLAS) Carriage Regulations.

Technical accuracy

To the best of our knowledge, the information in this document was correct at the time it was produced. However, Raymarine cannot accept liability for any

inaccuracies or omissions it may contain. In addition, our policy of continuous product improvement may change specifications without notice. As a result, Raymarine cannot accept liability for any differences between the product and this document. Please check the Raymarine website (www.raymarine.com) to ensure you have the most up-to-date version(s) of the documentation for your product.

Chapter 2: Document and product information

Chapter contents

- [2.1 Document information on page 14](#)
- [2.2 Product overview on page 16](#)
- [2.3 CHIRP DownVision™ overview on page 17](#)
- [2.4 CHIRP Sonar overview on page 17](#)

2.1 Document information

This document contains important information related to the installation of your Raymarine product.

The document includes information to help you:

- plan your installation and ensure you have all the necessary equipment;
- install and connect your product as part of a wider system of connected marine electronics;
- troubleshoot problems and obtain technical support if required.

This and other Raymarine product documents are available to download in PDF format from www.raymarine.com.

Applicable products

This document is applicable to the following products:

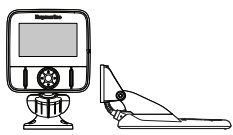
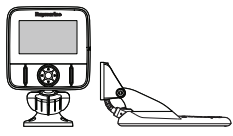
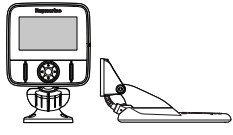
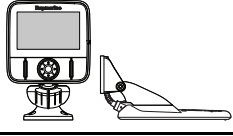
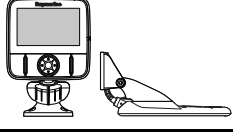
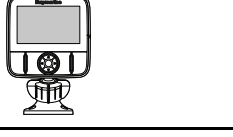
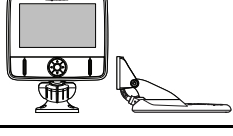
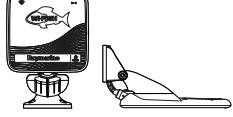
	Part number	Description
	E70291	Dragonfly-4 DV Standalone single channel Fishfinder display with transducer
	E70292	Dragonfly-4 DVS Standalone dual channel Fishfinder display with transducer
	E70294	Dragonfly-4 Pro Standalone dual channel Fishfinder / Chartplotter display with transducer
	E70306	Dragonfly-5 DVS Standalone dual channel Fishfinder display with transducer
	E70293	Dragonfly-5 Pro Standalone dual channel Fishfinder / Chartplotter display with transducer
	E70295	Dragonfly-5 M Standalone Chartplotter display
	E70320	Dragonfly-7 Pro Standalone dual channel Fishfinder / Chartplotter display with transducer
	E70290	Wi-Fish™ Standalone single channel Wi-Fi sonar module

Note: Dragonfly® products are standalone non-networkable products.

Applicable chapters

Some chapters in this manual are only applicable to certain product variants. The table below shows which chapters are applicable to each product variant.

Chapter	Variant
Chapter 1 Important information	All
Chapter 2 Document and product information	All
Chapter 3 Planning the installation	All
Chapter 4 Mounting	All
Chapter 5 Cables and connections	All
Chapter 6 Wi-Fish™	Wi-Fish™
Chapter 7 Getting started	DV, DVS, M and Pro
Chapter 8 Fishfinder applications	DV, DVS and Pro
Chapter 9 Chart application	M and Pro
Chapter 10 Mobile applications	Pro
Chapter 11 Tools & Settings	DVS and Pro
Chapter 12 Maintenance	All
Chapter 13 Troubleshooting	All
Chapter 14 Technical support	All
Chapter 15 Technical specification	All
Chapter 16 Spares and accessories	All

Software revision

Product software is updated regularly to add new features and improve existing functionality.



This handbook covers **Dragonfly®** software version: **LightHouse™ II Release 12**. Please refer to the *Software Releases* section for details on software releases. Check the Raymarine website to ensure you have the latest software and user manuals. www.raymarine.com.

Product documentation

The following documentation is applicable to your product:

Description	Part number
Dragonfly-4, Dragonfly-5, Dragonfly-7 and Wi-Fish™ installation and operation instructions Installation and operational instructions for the Dragonfly® range of products and the CPT-DV and CPT-DVS transducer	81358
Dragonfly-4, Dragonfly-5, Dragonfly-7 and Wi-Fish™ surface mount kit installation instructions Installation of a Dragonfly® using the surface mount adaptor kit.	87259
CPT-DV and CPT-DVS Transom mount transducer mounting template	87238

Document conventions

The following conventions are used throughout this handbook.

Select

The term 'Select' is used to describe the action of using the product's directional controls to highlight an item and then pressing the **OK** button to confirm the selection.

Directional controls

The term 'Directional controls' is used to describe the **Up**, **Down**, **Left** and **Right** controls.

Document illustrations

Your product may differ slightly from that shown in the illustrations in this document, depending on product variant and date of manufacture.

All images are provided for illustration purposes only.

User manuals Print Shop

Raymarine provides a Print Shop service, enabling you to purchase a high-quality, professionally-printed manual for your Raymarine product.

Printed manuals are ideal for keeping onboard your vessel, as a useful source of reference whenever you need assistance with your Raymarine product.

Visit <http://www.raymarine.co.uk/view/?id=5175> to order a printed manual, delivered directly to your door.

For further information about the Print Shop, please visit the Print Shop FAQ pages: <http://www.raymarine.co.uk/view/?id=5751>.

Note:

- Accepted methods of payment for printed manuals are credit cards and PayPal.
- Printed manuals can be shipped worldwide.
- Further manuals will be added to the Print Shop over the coming months for both new and legacy products.
- Raymarine user manuals are also available to download free-of-charge from the Raymarine website, in the popular PDF format. These PDF files can be viewed on a PC / laptop, tablet, smartphone, or on the latest generation of Raymarine multifunction displays.

2.2 Product overview

Dragonfly® products are standalone Fishfinder and / or Chartplotter products.

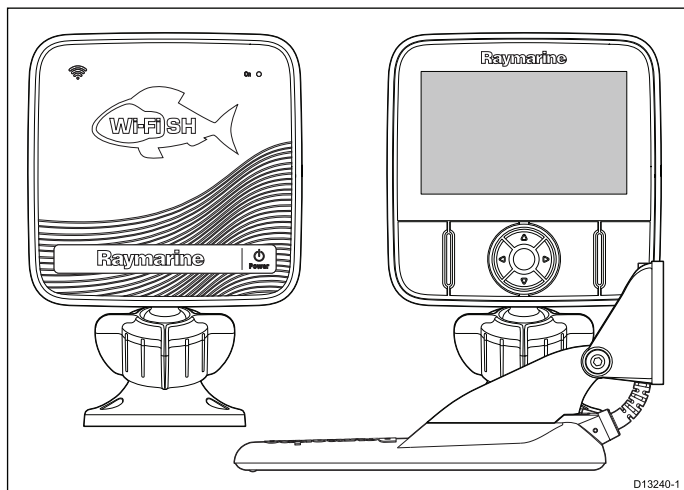

The following products are available:

Product	Features
Wi-Fish™	<ul style="list-style-type: none"> • 1 x CHIRP DownVision™ channel • Supplied with CPT-DV (CHIRP DownVision™) and temperature transom mount transducer • Built-in Wi-Fi (display on Android 4 and iOS 7 compatible smart devices) • Easy ball and socket display mounting
Dragonfly-4 DV	<ul style="list-style-type: none"> • 4.3' Bright all weather LED backlit display • 1 x CHIRP DownVision™ channel • Supplied with CPT-DV (CHIRP DownVision™) and temperature transom mount transducer • Easy ball and socket display mounting
Dragonfly-4 DVS	<ul style="list-style-type: none"> • 4.3' Bright all weather LED backlit display • Dual channel CHIRP DownVision™ and CHIRP Sonar channels. • Supplied with CPT-DVS (Combined CHIRP DownVision™, CHIRP sonar and temperature transom mount transducer) • Easy ball and socket display mounting
Dragonfly-4 Pro	<ul style="list-style-type: none"> • 4.3' Bright all weather LED backlit display • Dual channel CHIRP DownVision™ and CHIRP Sonar channels. • Supplied with CPT-DVS (Combined CHIRP DownVision™, CHIRP sonar and temperature transom mount transducer) • Easy ball and socket display mounting • Built-in Wi-Fi (display on Android 4 and iOS 7 compatible smart devices)

Product	Features
	<ul style="list-style-type: none"> • Built-in GNSS (GPS / GLONASS) receiver • Compatible with LightHouse™ charts, Navionics® and C-Map charts by Jeppesen®
Dragonfly-5 DVS	<ul style="list-style-type: none"> • 5' Bright all weather LED backlit display • Dual channel CHIRP DownVision™ and CHIRP Sonar channels. • Supplied with CPT-DVS (Combined CHIRP DownVision™, CHIRP sonar and temperature transom mount transducer) • Easy ball and socket display mounting
Dragonfly-5 Pro	<ul style="list-style-type: none"> • 5' Bright all weather LED backlit display • Dual channel CHIRP DownVision™ and CHIRP Sonar channels. • Supplied with CPT-DVS (Combined CHIRP DownVision™, CHIRP sonar and temperature transom mount transducer) • Easy ball and socket display mounting • Built-in Wi-Fi (display on Android 4 and iOS 7 compatible smart devices) • Built-in GNSS (GPS / GLONASS) receiver • Compatible with LightHouse™ charts, Navionics® and C-Map charts by Jeppesen®
Dragonfly-5 M	<ul style="list-style-type: none"> • 5' Bright all weather LED backlit display • Easy ball and socket display mounting • Built-in GNSS (GPS / GLONASS) receiver • Compatible with LightHouse™ charts, Navionics® and C-Map charts by Jeppesen®
Dragonfly-7 Pro	<ul style="list-style-type: none"> • 7' Bright all weather LED backlit display • Dual channel CHIRP DownVision™ and CHIRP Sonar channels. • Supplied with CPT-DVS (Combined CHIRP DownVision™, CHIRP sonar and temperature transom mount transducer) • Easy ball and socket display mounting • Built-in Wi-Fi (display on Android 4 and iOS 7 compatible smart devices) • Built-in GNSS (GPS / GLONASS) receiver • Compatible with LightHouse™ charts, Navionics® and C-Map charts by Jeppesen®

2.3 CHIRP DownVision™ overview

DownVision™ produces a wide-angle side-to-side beam and a thin fore-to-aft beam. The coverage of the **DownVision™** beam is a water column directly beneath and to the sides of the vessel.

DownVision™ beam

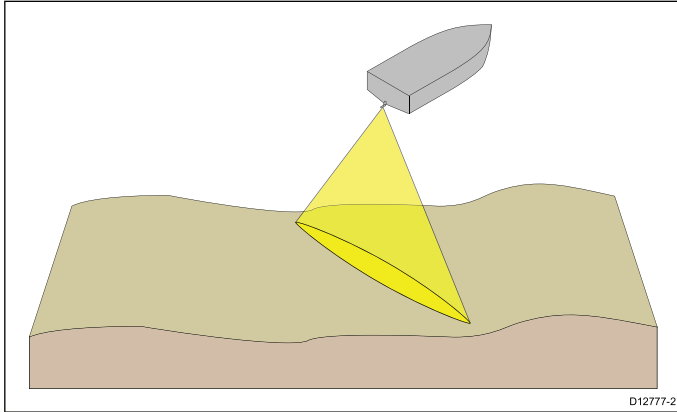

DownVision™ is effective at lower vessel speeds. In deeper waters the CHIRP bandwidth is automatically optimized to improve bottom lock and the detection of moving objects (e.g. fish) in the wider water column.

The wide, thin beam produces clear target returns. The use of CHIRP processing and a higher operating frequency provide a more detailed image, making it easier to identify bottom structures around which fish may reside.

CHIRP DownVision™ screen example

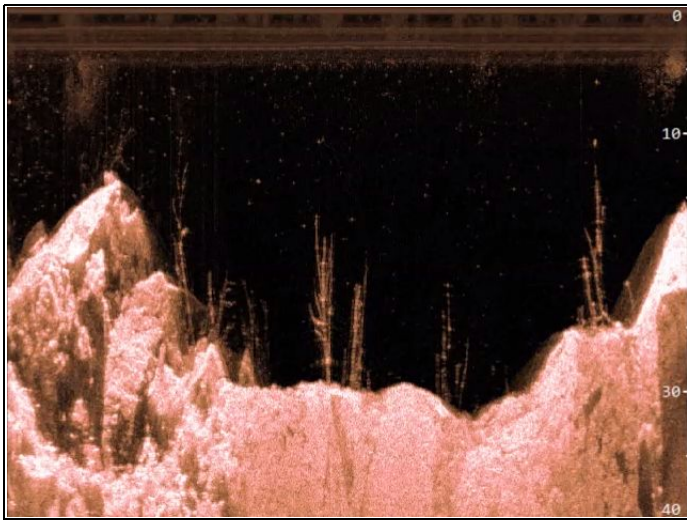

2.4 CHIRP Sonar overview

CHIRP sonar produces a conical shaped beam, the coverage of the conical beam is the water column directly beneath the vessel

Conical beam

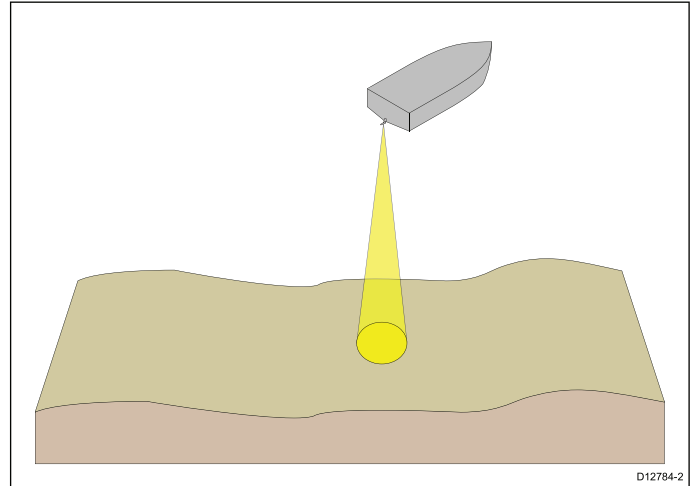

Sonar is effective at a range of speeds. In deeper waters the CHIRP bandwidth is automatically optimized to improve bottom lock and the detection of moving objects (e.g. fish) in the wider water column.

CHIRP sonar screen example

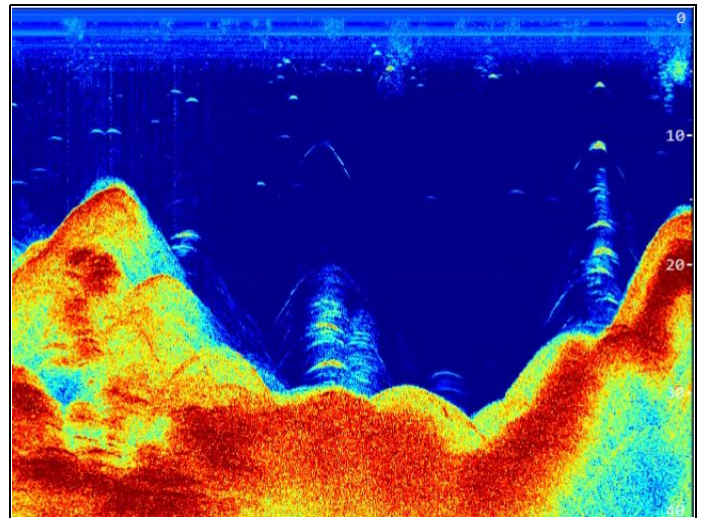

Chapter 3: Planning the installation

Chapter contents

- 3.1 Installation checklist on page 20
- 3.2 Parts supplied – **DV**, **DVS**, and **Pro** variants on page 20
- 3.3 Parts supplied – 5 M on page 21
- 3.4 Parts supplied —**Wi-Fish™** on page 21
- 3.5 **DownVision™** transducer compatibility on page 22
- 3.6 Tools required for installation — **Dragonfly® DV / DVS / Pro / Wi-Fish™** on page 23
- 3.7 Tools required for installation — **Dragonfly-5 M** on page 23
- 3.8 Software updates on page 24
- 3.9 Warnings and cautions on page 24
- 3.10 Selecting a location for the transducer on page 25
- 3.11 Cable routing on page 26
- 3.12 Selecting a location for the display on page 26
- 3.13 Installation process on page 28

3.1 Installation checklist

Installation includes the following activities:

Installation Task	
1	Plan your system.
2	Obtain all required equipment and tools.
3	Site all equipment.
4	Route all cables.
5	Drill cable and mounting holes.
6	Make all connections into equipment.
7	Secure all equipment in place.
8	Power on and test the system.

3.2 Parts supplied – DV, DVS, and Pro variants

The parts supplied with your product are shown below.

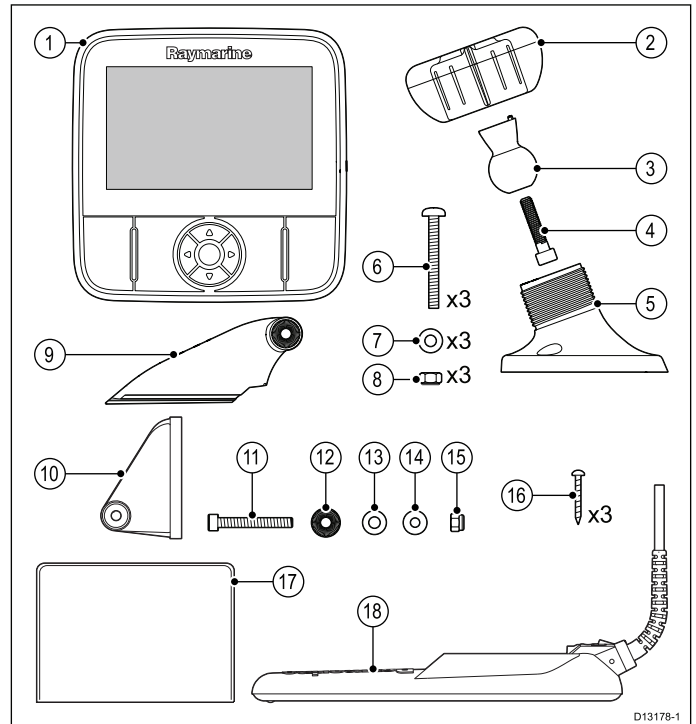

1. Display unit
2. Locking collar
3. Pivot ball
4. M6 Hex bolt
5. Display bracket base
6. 3 x M5 pozi-drive bolt
7. 3 x M5 washer
8. 3 x M5 locking nut
9. Ratchet arm
10. Mounting bracket
11. M5 Hex ratchet bolt
12. Ratchet plate
13. Compression washer
14. M5 washer
15. M5 locking nut
16. 3 x Self tapping screws
17. Documentation
18. Transducer with combined power cable

3.3 Parts supplied – 5 M

The parts supplied with your product are shown below.

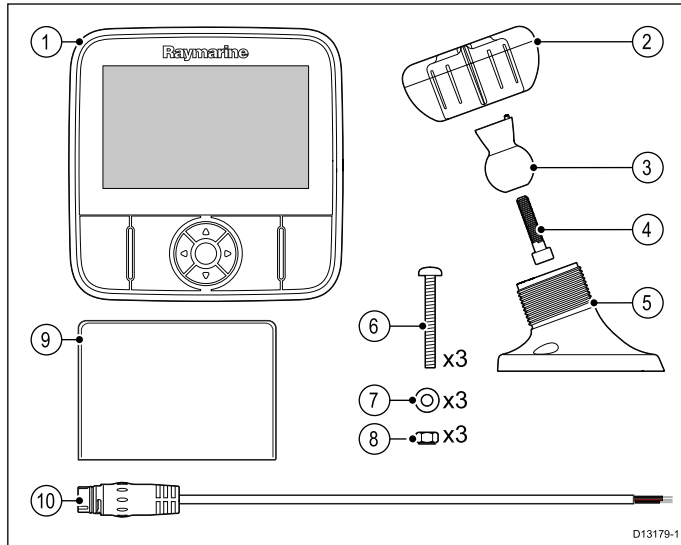

1. Display unit
2. Locking collar
3. Pivot ball
4. M6 Hex bolt
5. Display bracket base
6. 3 x M5 pozi-drive bolt
7. 3 x M5 washer
8. 3 x M5 locking nut
9. Documentation
10. 1.5 m (4.9 ft.) Power cable

3.4 Parts supplied —Wi-Fish™

The parts supplied with your product are shown below.

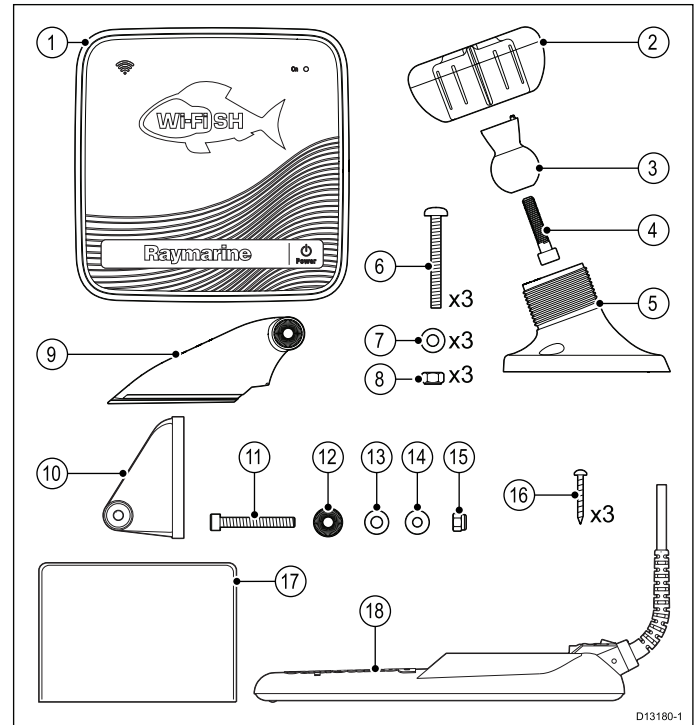

1. **Wi-Fish™** unit
2. Locking collar
3. Pivot ball
4. M6 Hex bolt
5. Unit bracket base
6. 3 x M5 pozi-drive bolt
7. 3 x M5 washer
8. 3 x M5 locking nut
9. Ratchet arm
10. Mounting bracket
11. M5 Hex ratchet bolt
12. Ratchet plate
13. Compression washer
14. M5 washer
15. M5 locking nut
16. 3 x Self tapping screws
17. Documentation
18. Transducer with combined power cable

3.5 DownVision™ transducer compatibility

Transducer	Description	Compatible displays
CPT-DV (R70373)	Single beam DownVision™ transducer (3 keyway connector)	<ul style="list-style-type: none"> • DV • Wi-Fish™
CPT-DVS (R70374)	Dual beam DownVision™ and Sonar transducer (3 keyway connector)	<ul style="list-style-type: none"> • DVS • Pro • Updated Dragonfly 6 • Updated Dragonfly 7 • * Legacy Dragonfly 6 • * Legacy Dragonfly 7
<ul style="list-style-type: none"> • Updated CPT-60 (A80195) • Updated CPT-70 (A80278) • Updated CPT-80 (A80279) 	Dual beam DownVision™ and Sonar transducer (3 keyway connector)	<ul style="list-style-type: none"> • DVS • Pro • Updated Dragonfly 6 • Updated Dragonfly 7 • * Legacy Dragonfly 6 • * Legacy Dragonfly 7
<ul style="list-style-type: none"> • Legacy CPT-60 (A80195) • Legacy CPT-70 (A80278) • Legacy CPT-80 (A80279) 	Dual beam DownVision™ and Sonar transducer (1 keyway connector)	<ul style="list-style-type: none"> • Legacy Dragonfly 6 • Legacy Dragonfly 7 • * DVS • * Pro

Note: * Adaptor cable required for connection.

Note:

- Connecting a **CPT-DV** to a **DVS** or a **Pro** will prevent the Sonar application from functioning.
- Connecting a **CPT-DVS** to a **DV** or a **Wi-Fish™** will not enable the Sonar application.
- The **M** cannot be connected to a transducer.

Product	3 keyway introduction date	3 keyway introduction serial number
Dragonfly 6 (E70085)	January 2015	E700850150001
Dragonfly 7 (E70231)	November 2014	E702311140712
CPT-60 (A80195)	December 2014	A801951240023
CPT-70 (A80278)	January 2015	A802780150001
CPT-80 (A80279)	January 2015	A802790150001

Legacy and updated products

Dragonfly 6, Dragonfly 7 displays and **CPT-60 / CPT-70 / CPT-80** transducer designs have been modified to include the improved 3 keyway connectors.

The table below identifies the effective manufacturing date for the improved keyway connectors.

3.6 Tools required for installation — Dragonfly® DV / DVS / Pro / Wi-Fish™

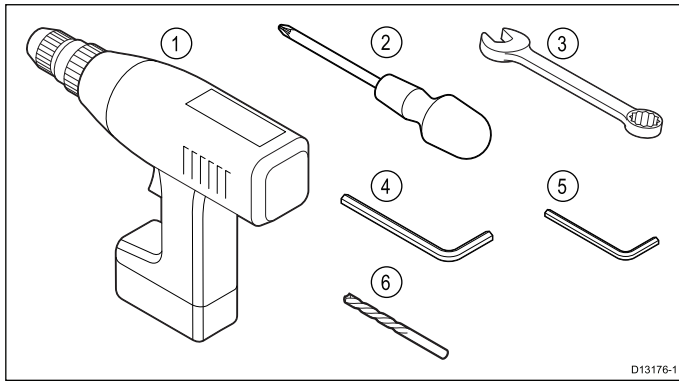

1. Cordless drill
2. Pozi-drive screw driver
3. 8 mm wrench (spanner)
4. 5 mm Hex wrench (allen key)
5. 4 mm Hex wrench (allen key)
6. Drill bit

You will also require:

- marine grade sealant
- a waterproof fuse holder and 5 A inline fuse.
- a paperclip (in case you need to remove the transducer from the bracket.)

3.7 Tools required for installation — Dragonfly-5 M

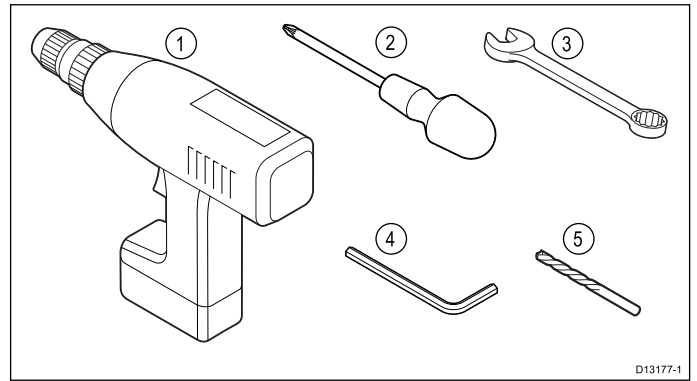

1. Cordless drill
2. Pozi-drive screw driver
3. 8 mm wrench (spanner)
4. 5 mm Hex wrench (allen key)
5. Drill bit

You will also require:

- a waterproof fuse holder and 5 A inline fuse.

3.8 Software updates

The software running on the product can be updated.

- Raymarine periodically releases software updates to improve product performance and add new features.
- You can update the software for your product using a connected and compatible multifunction display.
- Refer to www.raymarine.com/software/ for the latest software updates and the software update procedure for your product.
- If in doubt as to the correct procedure for updating your product software, refer to your dealer or Raymarine technical support.

Caution: Installing software updates

The software update process is carried out at your own risk. Before initiating the update process ensure you have backed up any important files.

Ensure that the unit has a reliable power supply and that the update process is not interrupted.

Damage caused by incomplete updates are not covered by Raymarine warranty.

By downloading the software update package, you agree to these terms.

3.9 Warnings and cautions

Important: Before proceeding, ensure that you have read and understood the warnings and cautions provided in the [Chapter 1 Important information](#) section of this document.

3.10 Selecting a location for the transducer

This product is supplied with a transom mount transducer. The guidelines below should be followed when selecting a location for the transducer.

Note: The transducer is not suitable for mounting on vessels where the transom is aft of the propeller(s).

For best performance the transducer must be installed in a location with the least turbulence and aeration. The most effective way to determine this is by checking the water flow around the transom whilst underway.

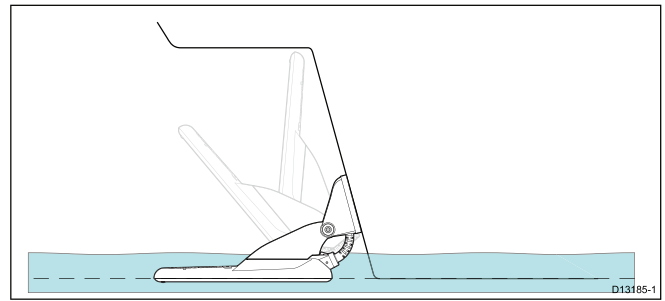

Note: Optimum transducer location will vary depending on vessel type. Optimum transducer height and angle should be obtained by testing the transducer with the vessel in the water.

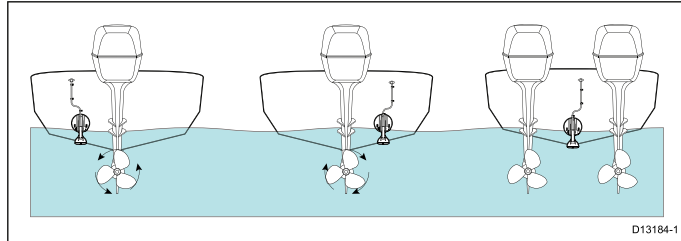

- Mount close to the keel (centerline), in a position where the transducer element will be fully submerged when the vessel is planing and turning.
- Mount a suitable distance from the propeller(s) to avoid wake.
- For clockwise rotating propellers, mount the transducer on the starboard side, for counter-clockwise, mount on the port side.
- On a twin engine vessel mount the transducer between the engines.
- Turbulence can be caused by a number of other factors such as steps (1), ribs (2), rows of rivets (3) and strakes (4). The turbulence appears aft of these locations.

Product dimensions – CPT-DV and CPT-DVS

The transducer's dimensions including the transom mounting bracket are shown below.

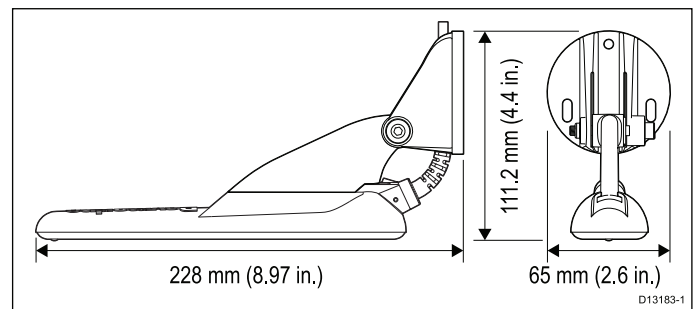

- The **CPT-DV** cable length is 4 m (13.1 ft.)
- The **CPT-DVS** cable length is 6 m (19.7 ft.)

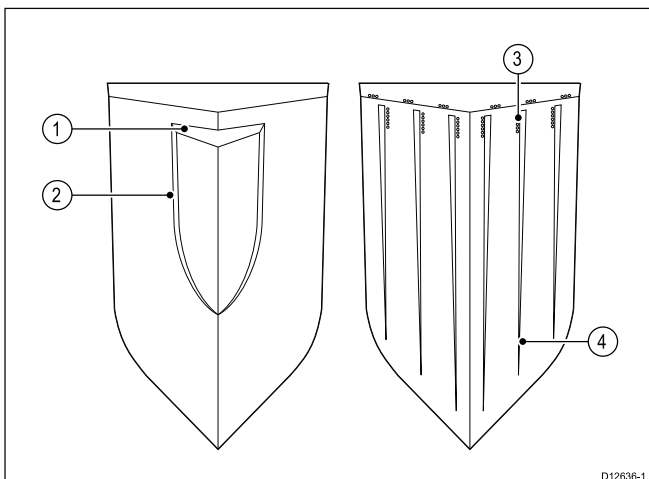

- Air trapped under the front of the vessel can travel under the hull and appear as aeration aft.
- If installing on the step of a stepped transom, allow sufficient room above the transducer for transducer kick up.

3.11 Cable routing

Cable routing requirements for the transducer cable.

Important: To avoid interference, the cable must be routed as far away from VHF radio antenna cables as possible.

- Check that the cable is long enough to reach the equipment it will be connected to. An optional 4 m (13.1 ft) extension cable is available if required.
- Ensure there is enough slack in the transducer cable, at the transducer end, to allow the transducer to pivot up and down.
- Secure the cable at regular intervals using cable clips (not supplied).
- Any excess cable should be coiled up at a convenient location.

3.12 Selecting a location for the display

General location requirements

When selecting a location for the unit it is important to consider a number of factors.

Ventilation requirements

To provide adequate airflow:

- Ensure that equipment is mounted in a compartment of suitable size.
- Ensure that ventilation holes are not obstructed.
- Ensure adequate separation of equipment.

Mounting surface requirements

Ensure units are adequately supported on a secure surface. Do NOT mount units or cut holes in places which may damage the structure of the vessel.

Cable routing requirements

Ensure the unit is mounted in a location which allows proper routing and connection of cables:

- Minimum cable bend radius of 100 mm (3.94 in) is required unless otherwise stated.
- Use cable supports to prevent stress on connectors.

Electrical interference

Select a location that is far enough away from devices that may cause interference, such as motors, generators and radio transmitters/receivers.

GPS location requirements

In addition to general guidelines concerning the location of marine electronics, there are a number of environmental factors to consider when installing equipment with an internal GPS antenna.

Mounting location

• Above Decks mounting:

It is recommended that the display is mounted above decks as this provides optimal GPS performance.

• Below Decks mounting:

GPS performance may be less effective when mounted below decks.

Vessel construction

The construction of your vessel can have an impact on GPS performance. For example, the proximity of heavy structures such as a structural bulkhead, or the interior of larger vessels may result in a reduced GPS signal. Before locating equipment with an internal GPS antenna below decks, seek professional assistance.

Prevailing conditions

The weather and location of the vessel can affect the GPS performance. Typically calm clear conditions provide for a more accurate GPS fix. Vessels at extreme northerly or southerly latitudes may also

receive a weaker GPS signal. GPS antenna mounted below decks will be more susceptible to performance issues related to the prevailing conditions.

Compass safe distance

To prevent potential interference with the vessel's magnetic compasses, ensure an adequate distance is maintained from the display.

When choosing a suitable location for the display you should aim to maintain the maximum possible distance between the display and any compasses. Typically this distance should be at least 1 m (3 ft) in all directions. However for some smaller vessels it may not be possible to locate the display this far away from a compass. In this situation, the following figures provide the minimum safe distance that should be maintained between the display and any compasses.

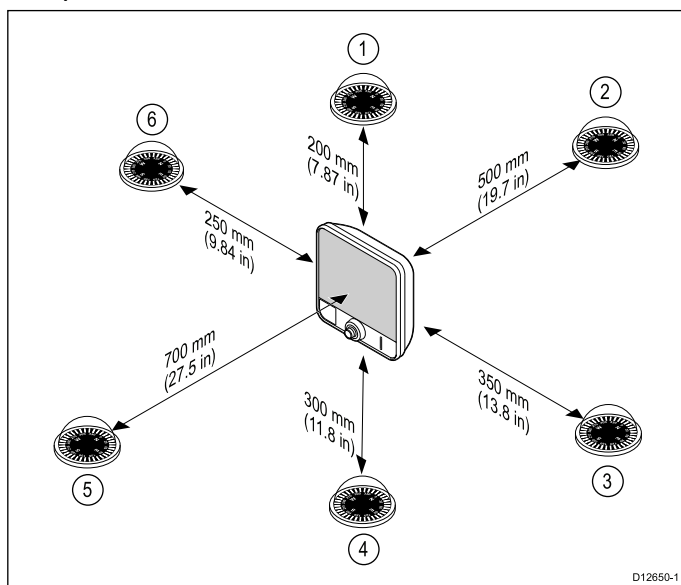

Item	Compass position in relation to display	Minimum safe distance from display
1	Top	200 mm (7.87 in.)
2	Rear	500 mm (19.7 in.)
3	Right-hand side	350 mm (13.8 in.)
4	Underside	300 mm (11.8 in.)
5	Front	700 mm (27.5 in.)
6	Left-hand side	250 mm (9.84 in.)

Viewing angle considerations

As display contrast and color are affected by the viewing angle, If you intend to surface mount the display, it is recommended that you temporarily power up the display when planning the installation, to enable you to identify which location gives the optimum viewing angle.

Wi-Fi location requirements

A number of factors can influence Wi-Fi performance, it is important to ensure you test the Wi-Fi performance, at the desired location before installing Wi-Fi enabled products.

Distance and signal strength

The distance between Wi-Fi products should always be kept to a minimum. Do not exceed the maximum stated range of your Wi-Fi product (Maximum range will vary for each device).

Wi-Fi performance degrades over distance so products farther away will receive less network bandwidth. Products installed close to their maximum Wi-Fi range may experience slow connection speeds, signal drop outs or not being able to connect at all.

Line of sight and obstacles

For best results the Wi-Fi product should have a clear, direct line of sight to the product it will be connected to. Any physical obstructions can degrade or even block the Wi-Fi signal.

The construction of your vessel can also have an impact on Wi-Fi performance. For example, metal structural bulkheads and roofing will reduce and in certain situations, block the Wi-Fi signal.

If the Wi-Fi signal passes through a bulkhead containing power cables this can also degrade Wi-Fi performance.

Reflective surfaces such as metal surfaces, some types of glass and even mirrors can drastically effect performance or even block the Wi-Fi signal.

interference and other equipment

Wi-Fi products should be installed at least 1m (3 ft) away from:

- other Wi-Fi enabled products
- transmitting products that send wireless signals in the same frequency range
- other electrical, electronic or electromagnetic equipment that may generate interference

Interference from other peoples Wi-Fi products can also cause interference with your products. You can use a Wi-Fi analyzer tool to assess the best Wi-Fi channel (channel not in use or used by least amount of devices) for you to use.

Product dimensions – Dragonfly-4 and Dragonfly-5

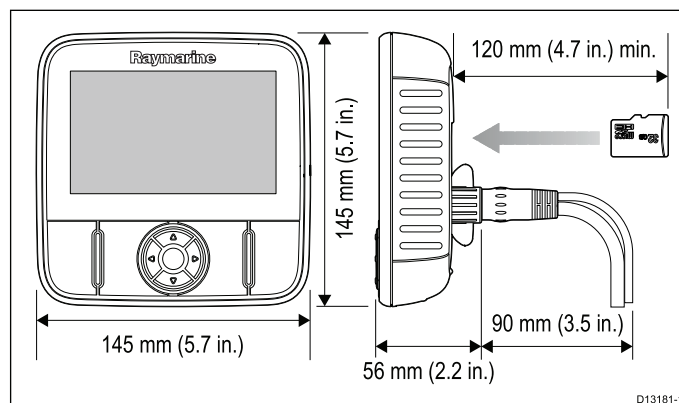

Care points:

- For variants with built-in GPS, install in a location where the GPS performance will not be affected by vessel structure; test GPS performance before installation.
- Allow a minimum of 120 mm (4.7 in.) behind the display for inserting and removing a MicroSD card.

- Allow enough room for display angle adjustment.
- Allow enough head room to remove the display from the bracket.

3.13 Installation process

The steps listed below are required to successfully install your product and ensure optimum performance.

1. Mounting the transducer.
2. Mounting the display.
3. Testing the transducer.
4. Finishing the transducer mounting.

Product dimensions – Dragonfly–7

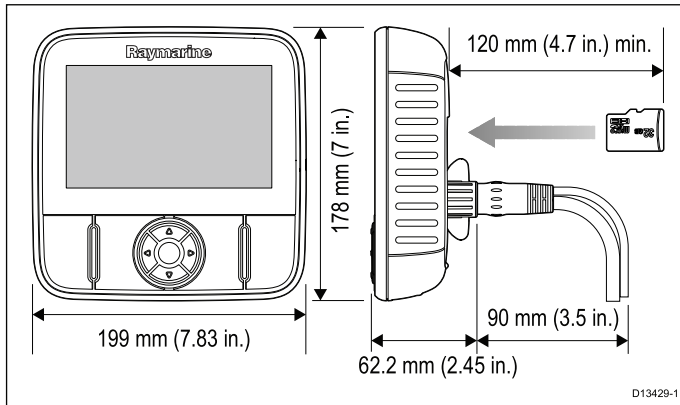

Care points:

- For variants with built-in GPS, install in a location where the GPS performance will not be affected by vessel structure; test GPS performance before installation.
- Allow a minimum of 120 mm (4.7 in.) behind the display for inserting and removing a MicroSD card.
- Allow enough room for display angle adjustment.
- Allow enough head room to remove the display from the bracket.

Product dimensions — Wi-Fish™

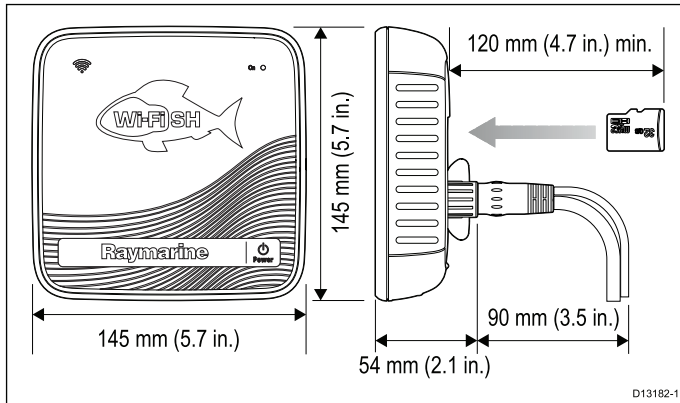

Care points:

- Allow of minimum of 120 mm (4.7 in.) behind the unit for inserting and removing an MicroSD card.
- Allow enough room for unit angle adjustment.
- Allow enough head room to remove the unit from the bracket.

Chapter 4: Mounting

Chapter contents

- 4.1 Mounting the transom mount bracket on page 30
- 4.2 Mounting the transducer on page 30
- 4.3 Mounting the unit on page 31
- 4.4 Testing and adjusting the transducer on page 32
- 4.5 Finalizing the transducer mounting on page 33

4.1 Mounting the transom mount bracket

The transducer must be mounted on the transom using the mounting bracket provided. The steps below describe the initial mounting steps required in order to test your transducers performance. After testing the transducer you must finish the mounting following the instructions in the *Finishing the transducer mounting* section.

1. Fix the transducer mounting template to the selected location, using masking or self-adhesive tape.

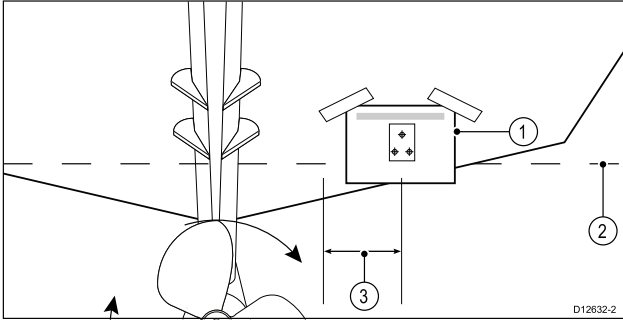

1	Transducer mounting template
2	Waterline
3	Mounting away from propeller

2. Ensure the template is parallel to the waterline.
3. Drill 2 x holes for the adjustment slot screws as indicated on the template.

Note: Do NOT drill the third mounting hole at this stage.

4. Fill the 2 holes with marine grade sealant.
5. Using a pozi-drive screw driver and the screws provided, secure the transom mount bracket using the 2 adjustment slots.

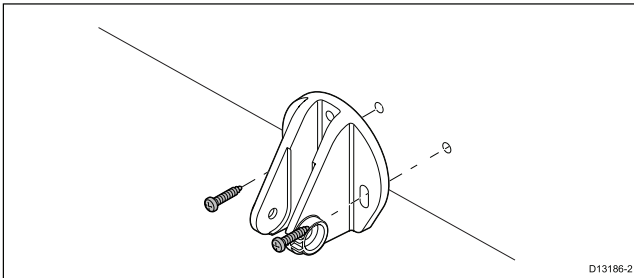

Note: The third locking screw is not used until the transducer has been successfully tested.

4.2 Mounting the transducer

The transducer must be mounted on the transom using the mounting bracket provided. The steps below describe the initial mounting steps required in order to test your transducers performance. After testing the transducer you must finish the mounting following the instructions in the *Finishing the transducer mounting* section.

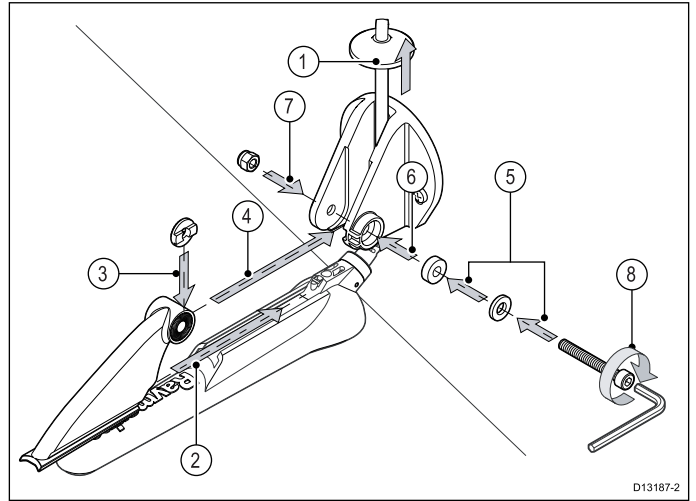

1. Feed the transducer cable between the posts on the mounting bracket as shown.
2. Slide the ratchet arm into the guide on the top of the transducer, ensuring it locks in place.
3. Hold the ratchet plate in place on the ratchet arm as shown.
4. Insert the ratchet arm between the mounting bracket posts, aligning the center hole with the holes in the posts.
5. Slide the M5 washer and then the compression washer onto the ratchet bolt.
6. Slide the ratchet bolt through the mounting bracket assembly.
7. Insert the M5 locking nut into the captive housing on the mounting bracket.
8. Using a 4 mm Hex wrench (allen key) tighten the ratchet bolt until the ratchet mechanism is engaged but can still be adjusted by hand.
9. Position the transducer so that the bottom face of the transducer will be parallel with the waterline and tighten the ratchet bolt.

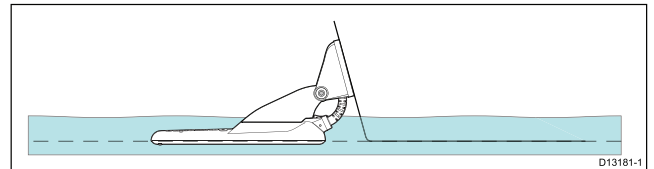

The transducer position will be adjusted further during testing.

4.3 Mounting the unit

The unit is mounted using the bracket provided.

Before mounting ensure that you have:

- selected a suitable location.
- installed the transducer and routed the power/transducer cable to the selected location.

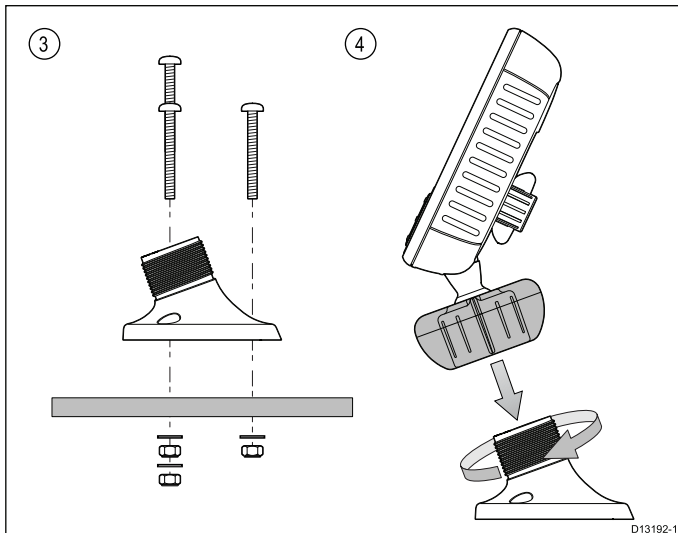
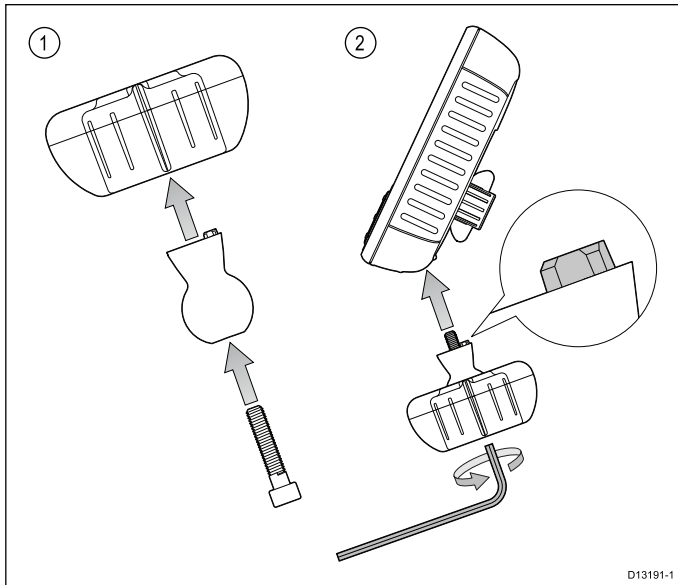

1. Slide the Hex (allen) bolt through the pivot ball, then slide the pivot ball through the center of the bracket locking collar.
2. Using a 5 mm Hex (allen) key (not supplied), screw the Hex (allen) bolt into the underside of the unit, ensuring the locating tabs are correctly aligned.
3. Using the fixings provided mount the bracket base to the mounting surface as follows:
 - i. Mark the location of the bracket base's mounting holes on the chosen mounting surface.
 - ii. Drill holes for the fixings using a suitable drill, ensuring there is nothing behind the surface that may be damaged.
 - iii. Use a pozi-drive screw driver and an 8 mm wrench (spanner) to attach the bracket base securely to the mounting surface using the fixings provided.
4. Position the unit at the desired angle and secure by tightening the locking collar.

The unit can be removed from the bracket, by unscrewing the locking collar.

Dragonfly-7 Pro mounting using RAM® mounts

The **Dragonfly-7 Pro** can also be bracket mounted using **RAM®** mounts compatible with the RAM 1" Tough-Ball™ with M6-1 x 6mm Male threaded post (Part Number: RAP-B-379U-M616).

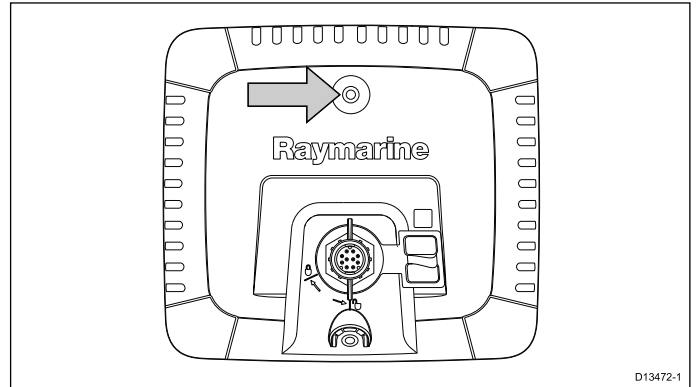

The threaded post can be attached to the M6 captive nut, located top center on the rear of the display.

Website link: <http://www.rammount.com/part/RAP-B-379U-M616>

4.4 Testing and adjusting the transducer

Once the initial mounting procedures have been carried out, the transducer must be tested prior to finishing the mounting.

The testing should be carried out with your vessel in the water, with a depth greater than 0.7 m (2.3 ft) but less than the maximum depth range of the transducer.

Important: The Sonar channel will be able to maintain readings at higher vessel speeds and at greater depths than the **DownVision™** application.

1. Press and hold the **Power** button to power the unit on.
2. Complete the Start-up wizard and tutorial.
3. Open the relevant application.
The bottom should be visible onscreen and a depth reading displayed.
4. Start moving your vessel at a low speed, ensuring you have a depth reading and a clear image is displayed.
5. Gradually increase the vessel speed whilst checking the display, if the image becomes poor or the bottom is missing at lower speeds then the transducer needs to be adjusted.
6. Angle and height adjustments should be made in small increments and re-tested each time until you obtain optimum performance.

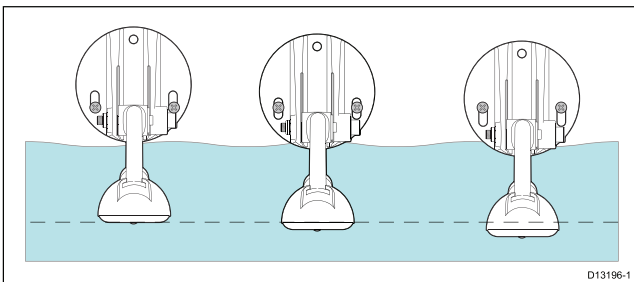
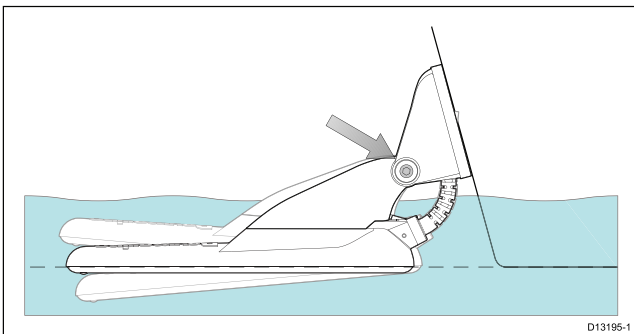

7. Loosen the ratchet arm bolt to adjust the transducer angle.
8. Loosen the 2 mounting bracket screws to adjust the transducer height.
9. Re-tighten the ratchet arm bolt and mounting screws before re-testing.

Note:

- It may not always be possible to obtain depth readings at higher speeds due to air bubbles passing under the transducer.
- It may be necessary to make several adjustments to the transducer before obtaining optimum performance.
- If the transducer requires repositioning ensure all old holes are filled with marine grade sealant.

Removing the transducer

The transducer can be released from the bracket by inserting a small metal rod such as a paperclip into the transducer release hole located as shown.

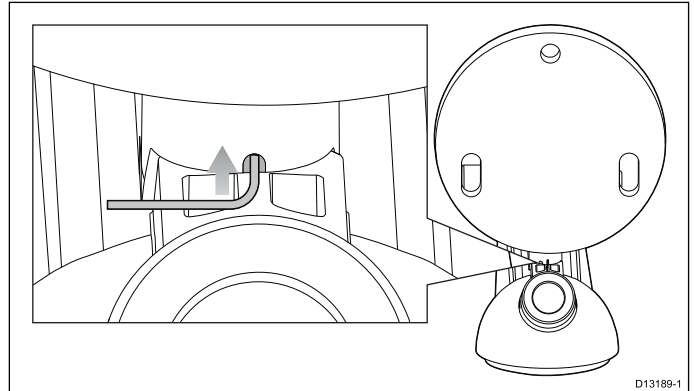

1. Insert the metal rod into the transducer release hole.
2. Slide the transducer off of the bracket.

4.5 Finalizing the transducer mounting

Once you have achieved optimum performance at the desired vessel speeds the transducer must be locked into position to complete the installation.

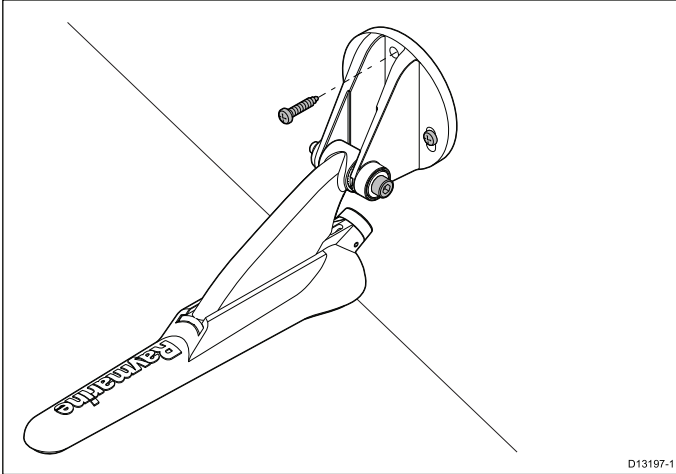

1. Drill the locking hole location taking care not to damage the mounting bracket.
2. Fill the locking hole with marine grade sealant.
3. Secure the transducer and bracket by fully tightening all 3 mounting screws.
4. Secure the ratchet arm bolt, by tightening until the compression washer is compressed and then add another 1/4 turn. If the transducer kicks up at speed then tighten further.

Important: Take care to ensure that the pivot bolt is not overtightened as this will prevent kick-up and may cause damage.

Chapter 5: Cables and connections

Chapter contents

- 5.1 General cabling guidance on page 36
- 5.2 Connections overview on page 36
- 5.3 Cable connection –**DV**, **DVS**, **Pro** and **Wi-Fish™** on page 38
- 5.4 Connecting the power cable - 5 M on page 38
- 5.5 Extension cable connection on page 41

5.1 General cabling guidance

Cable types and length

It is important to use cables of the appropriate type and length

- Unless otherwise stated use only standard cables of the correct type, supplied by Raymarine.
- Ensure that any non-Raymarine cables are of the correct quality and gauge. For example, longer power cable runs may require larger wire gauges to minimize voltage drop along the run.

Routing cables

Cables must be routed correctly, to maximize performance and prolong cable life.

- Do NOT bend cables excessively. Wherever possible, ensure a minimum bend diameter of 200 mm (8 in) / minimum bend radius of 100 mm (4 in).

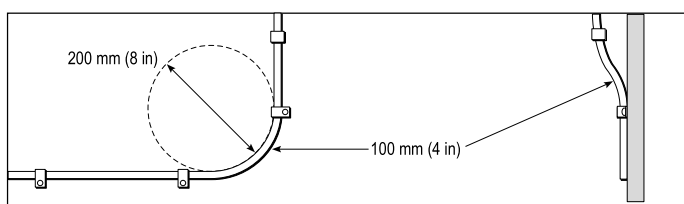

- Protect all cables from physical damage and exposure to heat. Use trunking or conduit where possible. Do NOT run cables through bilges or doorways, or close to moving or hot objects.
- Secure cables in place using tie-wraps or lacing twine. Coil any extra cable and tie it out of the way.
- Where a cable passes through an exposed bulkhead or deckhead, use a suitable watertight feed-through.
- Do NOT run cables near to engines or fluorescent lights.

Always route data cables as far away as possible from:

- other equipment and cables,
- high current carrying AC and DC power lines,
- antennae.

Strain relief

Ensure adequate strain relief is provided. Protect connectors from strain and ensure they will not pull out under extreme sea conditions.

Cable shielding

Ensure that the cable is properly shielded that the cable shielding is intact (e.g. hasn't been scraped off by being squeezed through a tight area).

5.2 Connections overview

Dragonfly-4, Dragonfly-5, Dragonfly-7 Pro, Wi-Fish™ products and the **CPT-DV** and **CPT-DVS** include connectors with a 3 keyway guide. Depending on date of manufacture **Dragonfly 6, Dragonfly 7** products and **CPT-60/ CPT-70 / CPT-80** transducers are available with 1 keyway guide (Legacy) or 3 keyway guide (Updated). Adaptor cables can be used to connect 1 keyway connectors to 3 keyway connectors.

Rear connector / Locking collar

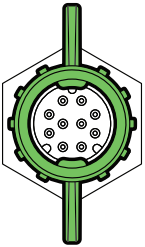
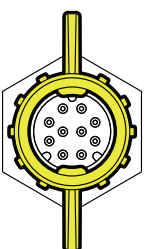
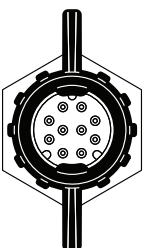
Connector	Description	Unit / Display	Compatible transducer
	Red – 1 keyway	<ul style="list-style-type: none"> • Legacy Dragonfly 6 • Legacy Dragonfly 7 	<ul style="list-style-type: none"> • Legacy CPT-60 • Legacy CPT-70 • Legacy CPT-80
	Green – 3 keyway	<ul style="list-style-type: none"> • DVS • Pro • Updated Dragonfly 6 • Updated Dragonfly 7 	<ul style="list-style-type: none"> • CPT-DVS • Updated CPT-60 • Updated CPT-70 • Updated CPT-80
	Yellow – 3 keyway	<ul style="list-style-type: none"> • DV • Wi-Fish™ 	<ul style="list-style-type: none"> • CPT-DV
	Black – 3 keyway	<ul style="list-style-type: none"> • 5 M 	<ul style="list-style-type: none"> • N/A – 5 M power connector

Transducer cable connectors

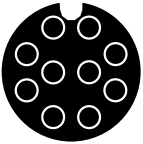
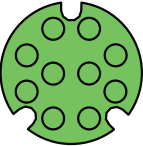
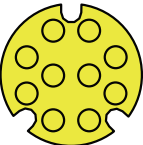
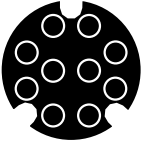
Cable Connector	Description	Transducer	Compatible unit / display
	Black – 1 keyway	<ul style="list-style-type: none"> Legacy CPT-60 Legacy CPT-70 Legacy CPT-80 	<ul style="list-style-type: none"> Legacy Dragonfly 6 Legacy Dragonfly 7
	Green – 3 keyway	<ul style="list-style-type: none"> CPT-DVS Updated CPT-60 Updated CPT-70 Updated CPT-80 	<ul style="list-style-type: none"> DVS Pro Updated Dragonfly 6 Updated Dragonfly 7
	Yellow – 3 keyway	<ul style="list-style-type: none"> CPT-DV 	<ul style="list-style-type: none"> DV Wi-Fish™
	Black – 3 keyway	<ul style="list-style-type: none"> N/A – 5 M power connector 	<ul style="list-style-type: none"> 5 M

Legacy and updated products

Dragonfly 6, Dragonfly 7 displays and **CPT-60 / CPT-70 / CPT-80** transducer designs have been modified to include the improved 3 keyway connectors.

The table below identifies the effective manufacturing date for the improved keyway connectors.

Product	3 keyway introduction date	3 keyway introduction serial number
Dragonfly 6 (E70085)	January 2015	E700850150001
Dragonfly 7 (E70231)	November 2014	E702311140712
CPT-60 (A80195)	December 2014	A801951240023
CPT-70 (A80278)	January 2015	A802780150001
CPT-80 (A80279)	January 2015	A802790150001

Adaptor cables

Adaptor cables are available to enable connection of the older 1 keyway connectors to the new 3 keyway connectors.

Adaptor cable	Compatible transducer	Compatible display / unit
A80331 — CPT-DV / CPT-DVS (3 keyway) to Legacy Dragonfly 6 / Dragonfly 7 (1 keyway) adaptor cable	<ul style="list-style-type: none"> CPT-DVS CPT-DV Updated CPT-60 Updated CPT-70 Updated CPT-80 	<ul style="list-style-type: none"> Legacy Dragonfly 6 Legacy Dragonfly 7
A80332 — Legacy (1 keyway) CPT-60 / CPT-70/ CPT-80 transducer to Dragonfly-4 / Dragonfly-5 and Wi-Fish™ (3 keyway) adaptor cable	<ul style="list-style-type: none"> Legacy CPT-60 Legacy CPT-70 Legacy CPT-80 	<ul style="list-style-type: none"> DV DVS Pro Wi-Fish™ Updated Dragonfly 6 Updated Dragonfly 7

5.3 Cable connection –DV, DVS, Pro and Wi-Fish™

The unit has a combined power and transducer cable that is attached to the transducer.

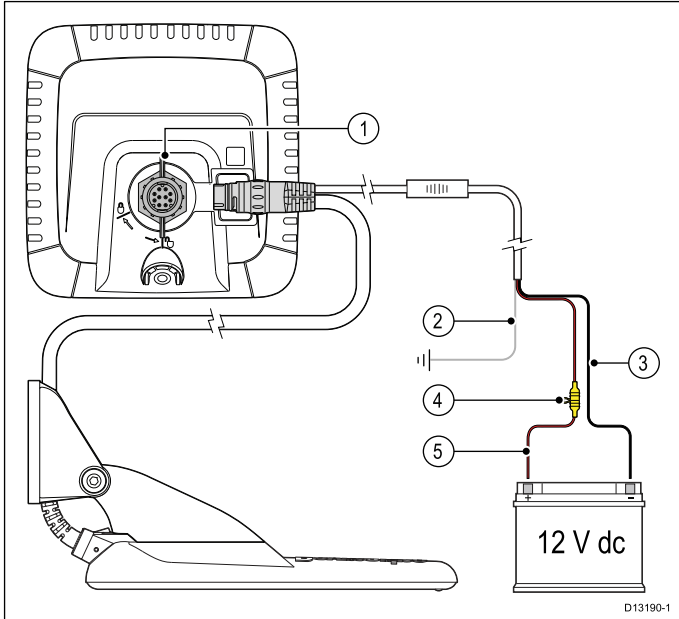

1. Connect the transducer / power connector to the rear of the unit and secure using the locking collar.
2. The drain wire should be connected to the vessel RF ground point. If your vessel has no ground point connect to the negative side of the vessel's power supply.
3. The Negative wire must be connected to the negative side of the 12 V dc power supply.
4. A fuse holder (not supplied) **MUST** be fitted to the positive wire using a suitably rated inline fuse or breaker.
5. The positive wire must be connected to the positive side of the 12 V dc power supply.

5.4 Connecting the power cable - 5 M

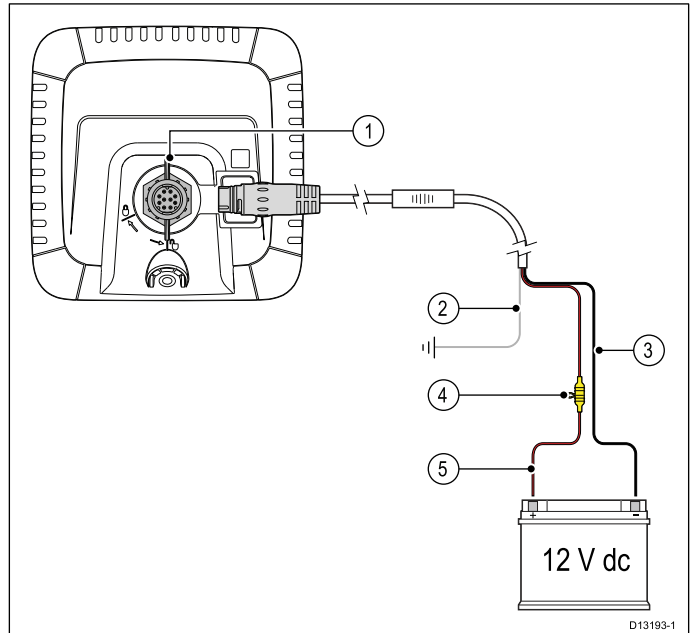

1. Connect the power cable to the rear of the display and secure using the locking collar.
2. The drain wire should be connected to the vessel RF ground point. If your vessel has no ground point connect to the negative side of the vessel's power supply.
3. The Negative wire must be connected to the negative side of the 12 V dc power supply.
4. A fuse holder (not supplied) **MUST** be fitted to the positive wire using a suitably rated inline fuse or breaker.
5. The positive wire must be connected to the positive side of the 12 V dc power supply.

Connecting the cable to the display

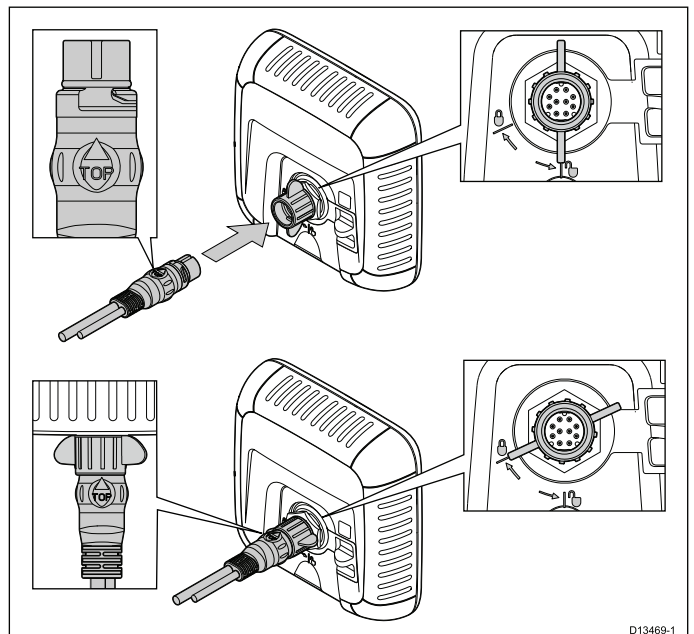

1. Ensure the locking collar is in the unlocked position.
2. Ensure that the cable connector is orientated correctly, rotate so that the word 'TOP' is on the top of the cable connector.

- Push the cable connector all the way in, the tip of the arrow should be nearly touching the locking collar.
- Rotate the locking collar clockwise 2 clicks, until in the locked position.



Warning: 12 Volt dc only
This product must only be connected to a **12 volt dc** power source.

In-line fuse and thermal breaker ratings

The following in-line fuse and thermal breaker ratings apply to your product:

	In-line fuse rating	Thermal breaker rating
Dragonfly-4 / Dragonfly-5	2 A slow blow	3 A (if only connecting one device)
Dragonfly-7	3 A slow blow	4 A (if only connecting one device)

Note:

- The suitable fuse rating for the thermal breaker is dependent on the number of devices you are connecting. If in doubt consult an authorized Raymarine dealer.
- Your product's power cable may have fitted in-line fuse, if not then you can add an in-line fuse to the positive wire of your products power connection.

Power distribution

Recommendations and best practice.

- The product is supplied with a power cable. Only use the power cable supplied with the product. Do NOT use a power cable designed for, or supplied with, a different product.
- Refer to the *Power connection* section for more information on how to identify the wires in your product's power cable, and where to connect them.
- See below for more information on implementation for some common power distribution scenarios.

Important: When planning and wiring, take into consideration other products in your system, some of which (e.g. sonar modules) may place large power demand peaks on the vessel's electrical system.

Note: The information provided below is for guidance only, to help protect your product. It covers common vessel power arrangements, but does NOT cover every scenario. If you are unsure how to provide the correct level of protection, please consult an authorized Raymarine dealer or a suitably qualified professional marine electrician.

Implementation — direct connection to battery

- The power cable supplied with your product may be connected directly to the vessel's battery, via a suitably rated fuse or breaker.
- The power cable supplied with your product may NOT include a separate drain wire. If this is the case, only the power cable's red and black wires need to be connected.
- If the supplied power cable is NOT fitted with an inline fuse, you MUST fit a suitably rated fuse or breaker between the red wire and the battery's positive terminal.
- Refer to the inline fuse ratings provided in the product's documentation.
- If you need to extend the length of the power cable supplied with your product, ensure you observe the dedicated *Power cable extensions* advice provided in the product's documentation.

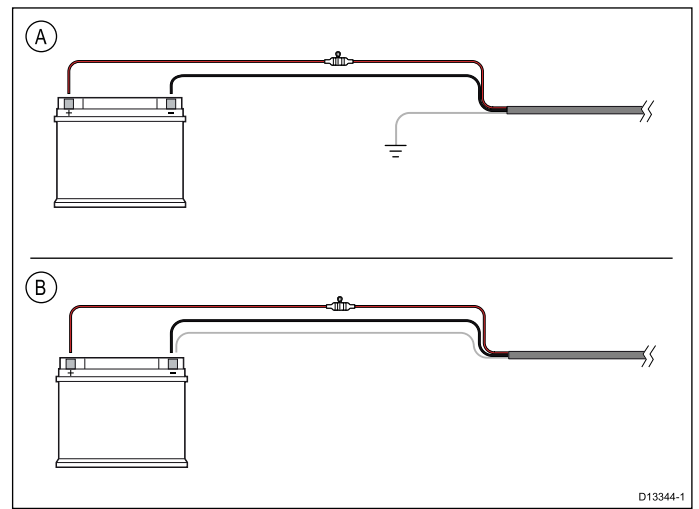

A	Battery connection scenario A: suitable for a vessel with a common RF ground point. In this scenario, if your product's power cable is supplied with a separate drain wire then it should be connected to the vessel's common ground point.
B	Battery connection scenario B: suitable for a vessel without a common grounding point. In this case, if your product's power cable is supplied with a separate drain wire then it should be connected directly to the battery's negative terminal.

Implementation — connection to distribution panel

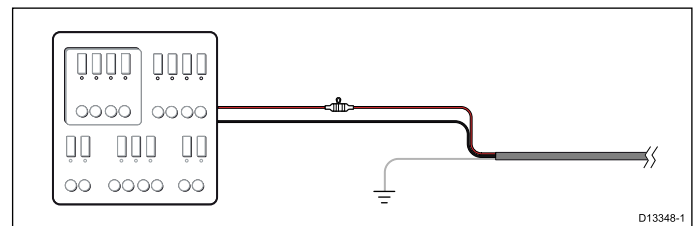

- Alternatively, the supplied power cable may be connected to a suitable breaker or switch on the vessel's distribution panel or factory-fitted power distribution point.
- The distribution point should be fed from the vessel's primary power source by 8 AWG (8.36 mm²) cable.

- Ideally, all equipment should be wired to individual suitably-rated thermal breakers or fuses, with appropriate circuit protection. Where this is not possible and more than 1 item of equipment shares a breaker, use individual in-line fuses for each power circuit to provide the necessary protection.
- In all cases, observe the recommended breaker / fuse ratings provided in the product's documentation.
- If you need to extend the length of the power cable supplied with your product, ensure you observe the dedicated *Power cable extensions* advice provided in the product's documentation.

Important: Be aware that the suitable fuse rating for the thermal breaker or fuse is dependent on the number of devices you are connecting.

Grounding

Ensure that you observe the separate grounding advice provided in the product's documentation.

More information

Raymarine recommends that best practice is observed in all vessel electrical installations, as detailed in the following standards:

- BMEA Code of Practice for Electrical and Electronic Installations in Boats
- NMEA 0400 Installation Standard
- ABYC E-11 AC & DC Electrical Systems on Boats
- ABYC A-31 Battery chargers and Inverters
- ABYC TE-4 Lightning Protection

Power cable extension

The product is supplied with a power cable, which can be extended if required.

- The power cable for each unit in your system should be run as a separate, single length of 2-wire cable from the unit to the vessel's battery or distribution panel.
- Raymarine recommends a **minimum** wire gauge of 18AWG (0.82 mm²) for any length of cable extension.
- For all lengths of extension to the power cable, ensure there is a continuous **minimum** voltage at the product's power connector of 10.8 V with a fully flat battery at 11 V.

Important: Be aware that some products in your system (such as sonar modules) can create voltage peaks at certain times, which may impact the voltage available to other products during the peaks.

Grounding — Dedicated drain wire

The power cable supplied with this product includes a dedicated shield (drain) wire for connection to a vessel's RF ground point.

It is important that an effective RF ground is connected to the system. A single ground point should be used for all equipment. The unit can be

grounded by connecting the shield (drain) wire of the power cable to the vessel's RF ground point. On vessels without an RF ground system the shield (drain) wire should be connected directly to the negative battery terminal.

The dc power system should be either:

- Negative grounded, with the negative battery terminal connected to the vessel's ground.
- Floating, with neither battery terminal connected to the vessel's ground



Warning: Product grounding

Before applying power to this product, ensure it has been correctly grounded, in accordance with the instructions provided.



Warning: Positive ground systems

Do not connect this unit to a system which has positive grounding.

5.5 Extension cable connection

An optional extension cable (A80312) can be used to extend the distance from the transducer to the unit by up to 4 m (13.1 ft).

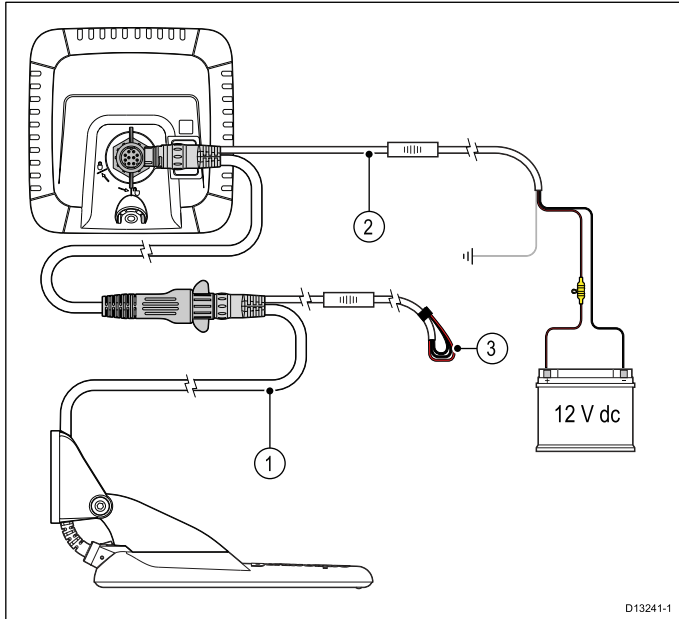

1. Existing cable.
2. Extension cable (connected to the vessel's power supply and to the existing cable).
3. Isolated power supply wires on existing transducer cable.

Note:

- Only 1 extension cable should be used per installation.
- The length of the power supply wires on the extension cable is 2 m (6.6 ft).

Maximum transducer cable length

The maximum cable length from the transducer to the unit is shown below.

CPT-DV	8 m (26.2 ft.) — 4 m (13.1 ft.) supplied cable + 4 m (13.1 ft.) extension cable
CPT-DVS	10 m (32.8 ft.) — 6 m (19.7 ft.) supplied cable + 4 m (13.1 ft.) extension cable

Note: Extending the transducer cable further than the maximum stated distance will cause poor performance.

Chapter 6: Wi-Fish™

Chapter contents

- 6.1 Wi-Fish controls on page 44
- 6.2 Switching the unit on and off on page 44
- 6.3 **Wi-Fish™** mobile app on page 45
- 6.4 **Wi-Fish™** initial set up on page 46
- 6.5 Depth Offset on page 46
- 6.6 Switching on the simulator — **Wi-Fish™** app on page 47
- 6.7 Opening the MicroSD card reader cover on page 47

6.1 Wi-Fish controls

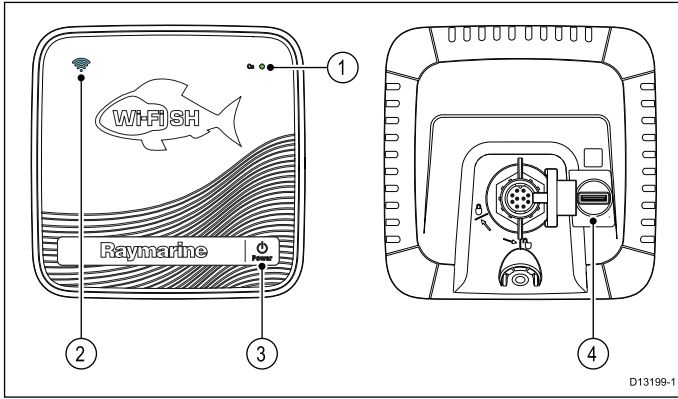

1. Power indicator (quick Green flash = initializing, slow Green flash = normal operation, Red = device failed)
2. Wi-Fi connection indicator (quick Blue flash = not connected, slow Blue flash = connected)
3. Power button
4. MicroSD card reader

6.2 Switching the unit on and off

Powering the unit on

1. Press and hold the **Power** button for approximately 3 seconds to power up the unit.
 - * On display products after approximately 5 seconds the splash screen is displayed.
2. * Press **OK** to accept the Limitations of Use disclaimer when it appears.

Note: * Does not apply to **Wi-Fish™**.

Powering the unit off

1. Press and hold the **Power** button for approximately 6 seconds.
 - On display products a 3 second count-down timer will be displayed.
 - To cancel the power off process, release the power button before the unit powers off.

Note: The unit will still draw a small amount of power from the battery when powered off, if this is a concern unplug the connector from the back of the unit.

6.3 Wi-Fish™ mobile app

The **Wi-Fish™** mobile app is available on iOS 7 or greater and Android 4 or greater. The app must be used to control the **Wi-Fish™** sonar module.

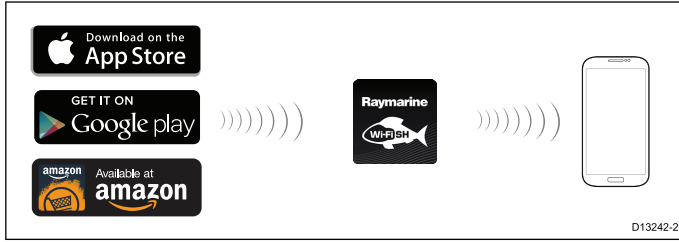

The **Wi-Fish™** app can be downloaded from the relevant app store for your device.

Connecting Wi-Fi — Wi-Fish™

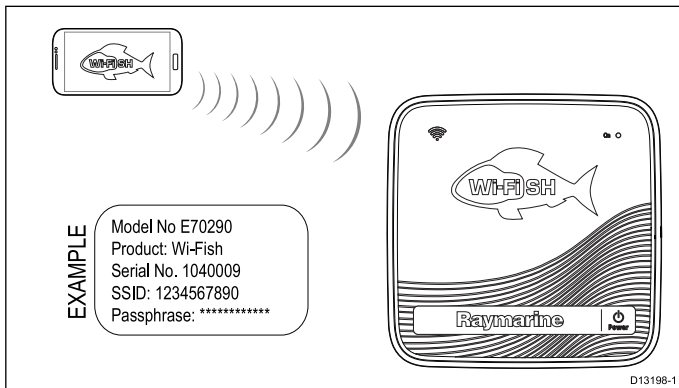

1. Install the **Wi-Fish™** app from the relevant app store.
2. Connect your smart device's Wi-Fi to the **Wi-Fish™** unit.
The product's unique network name, known as the SSID (Service Set Identifier) and Passphrase for your product can be found on the product label fixed to the bottom of the unit. It is recommended that you take note of these and retain somewhere safe for future reference.
3. Open the **Wi-Fish™** app.

Connecting your smart device

Your smart device's Wi-Fi connection must be connected to the product to enable use of the mobile **Wi-Fish™** app.

With the **Wi-Fish™** mobile app installed on your smart device:

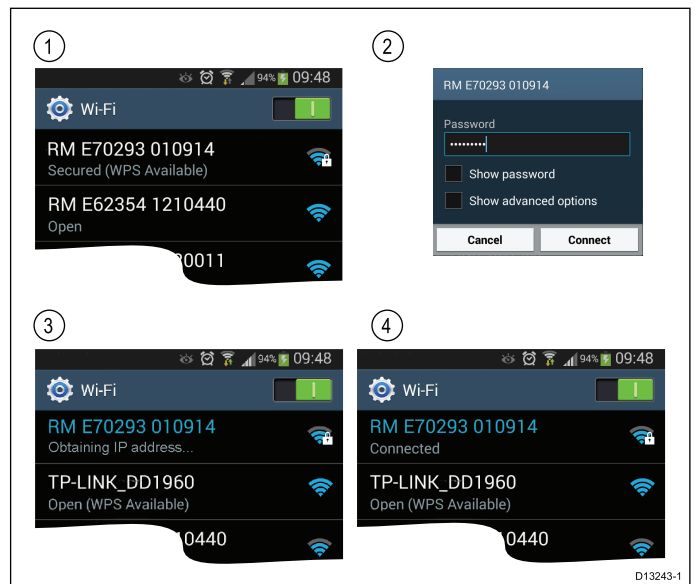

1. Open the Wi-Fi settings on your smart device and select your product's SSID from the list of available devices.
Your product's SSID can be found on the product label located on the bottom of the unit.
2. Enter your product passphrase.
Your product's passphrase can also be found on the product label located on the bottom of the unit.
3. Your device will now connect to the unit and obtain an IP address.
4. Once your device is connected you can open the **Wi-Fish™** app.

6.4 Wi-Fish™ initial set up

Once the **Wi-Fish™** unit is installed and connected to your smart device, which is running the latest version of the **Wi-Fish™** app, it is recommended that the following tasks are completed:

- Configure units of measure for depth and temperature readings
- Set a transducer offset
- View the app's Help pages
- Familiarize yourself with the product using Simulator Mode.

These options are available in the **Wi-Fish™** mobile app's **More** menu which includes the following settings:

- **Settings**
 - Transducer depth offset
 - Depth units
 - Temperature units
 - Simulator
- **Help**
- **About**

6.5 Depth Offset

Depths are measured from the transducer to the sea bed, but you can apply an offset value to the depth data, so that the displayed depth reading represents the depth to the sea bed from either the keel or the waterline.

Before attempting to set a waterline or keel offset, find out the vertical separation between the transducer and either the waterline or the bottom of the keel on your vessel, as appropriate. Then set the appropriate depth offset value.

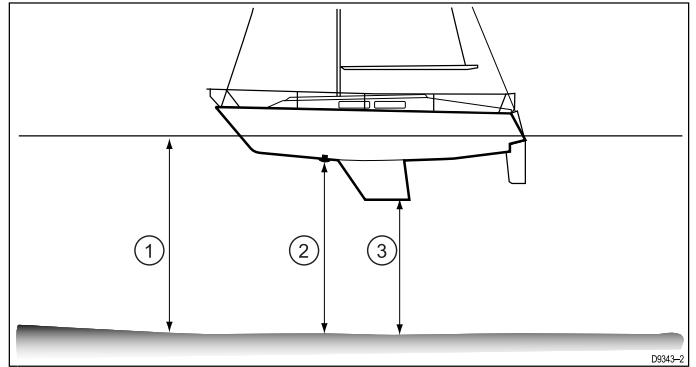

1	Waterline offset
2	Transducer / Zero offset
3	Keel offset

If an offset is not applied, displayed depth readings represent the distance from the transducer to the sea bed.

Assigning a transducer depth offset — Wi-Fish™ app

Follow the steps below to assign a depth offset value to your depth readings.

With the **Wi-Fish™** mobile app connected and running on your smart device:

1. Select the More icon (three vertical dots).
2. Select **Settings**.
3. Select **Transducer Depth Offset**.
4. Adjust the depth offset to the required value.

6.6 Switching on the simulator — Wi-Fish™ app

The simulator may be used to familiarize yourself with the features and functions of the product.

With the **Wi-Fish™** mobile app connected to your **Wi-Fish™** unit and running:

1. Select .
2. Select **Settings**.
3. Select **Simulator**.
4. Select On to switch simulator mode on, or
5. Select Off to switch the simulator mode off.

In simulator mode the app will have the same functionality, however simulated sonar data is displayed instead of live sonar data.

6.7 Opening the MicroSD card reader cover

The MicroSD card reader is located on the rear of the unit. The card reader is protected by a weatherproof cover.

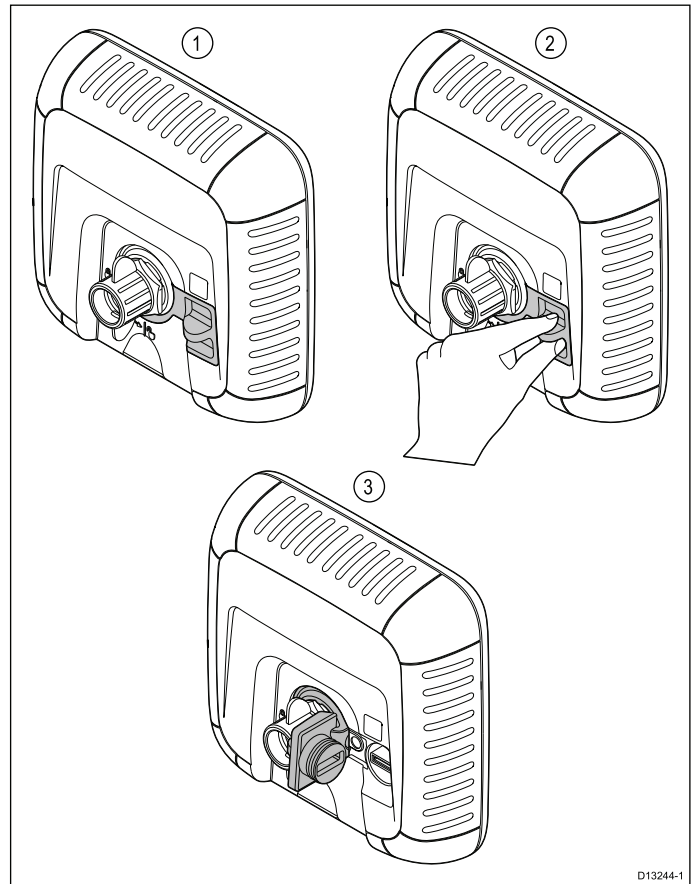

1. Cover closed
2. Opening cover
3. Cover open

1. Open the card reader cover by pulling backwards on the cover's handle until the cover is positioned as shown in (3) above.

The cover has a tight fit and may require some force to open the cover.

2. Fully close the card reader cover.

Important: When closing the cover ensure that it is fully pushed in and sealed all the way around the edge, this will provide the weatherproof seal.

Removing MicroSD card from its adaptor

MicroSD memory and cartography chart cards are usually supplied inserted into an SD card adaptor. The card will need to be removed from the adaptor before inserting into your display.

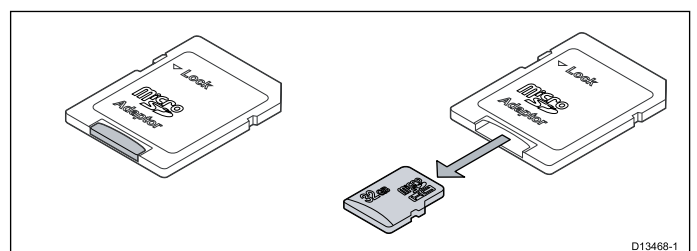

Inserting a MicroSD card

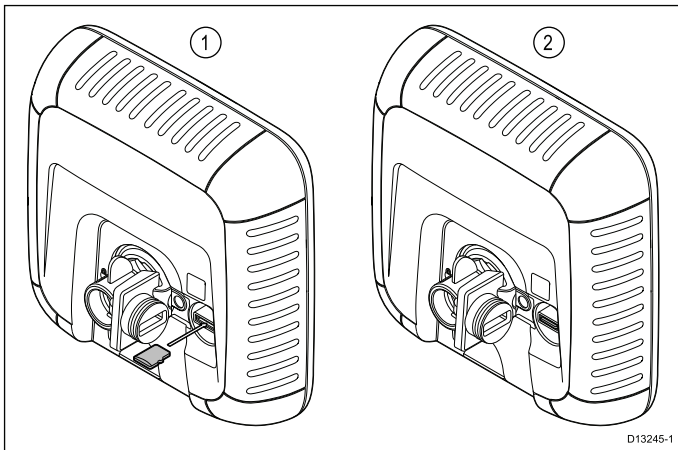

With the card reader's cover open:

1. Insert the card with the contacts facing down.
2. Gently press the MicroSD card all the way into the card reader slot.
3. Fully close the card reader cover.

Important: When closing the cover ensure that it is fully pushed in and sealed all the way around the edge, this will provide the weatherproof seal.

Removing a MicroSD card

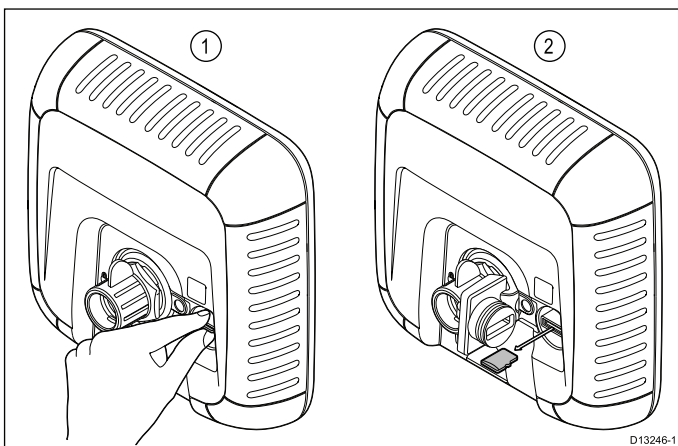

1. On display products select **Eject SD Card** from the Shortcuts page.
2. Open the card reader's cover.
3. Pinch the protruding edge of the MicroSD card between your index finger and thumb and pull the card clear of the card reader slot.
4. Fully close the card reader cover.

Important: When closing the cover ensure that it is fully pushed in and sealed all the way around the edge, this will provide the weatherproof seal.

Chapter 7: Getting started

Chapter contents

- 7.1 Controls — **DV**, **DVS**, **Pro** and **M** on page 50
- 7.2 Switching the unit on and off on page 50
- 7.3 Initial set up procedures on page 51
- 7.4 Satellite-based navigation on page 52
- 7.5 Checking the sonar application on page 53
- 7.6 Checking the **DownVision™** application on page 54
- 7.7 Shortcuts page on page 54
- 7.8 Applications on page 55
- 7.9 View switcher on page 56
- 7.10 Memory cards and chart cards on page 57
- 7.11 Learning resources on page 58

7.1 Controls — DV, DVS, Pro and M

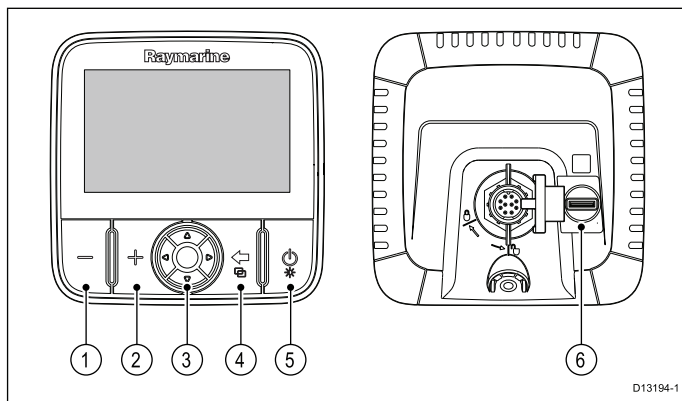

1	- button Zoom out / Range out
2	+ button Zoom in / Range in
3	Directional track pad with OK button — Used for navigating menus and applications and selecting items.
4	Back button / View switcher button <ul style="list-style-type: none"> • Press once to return to a previous menu or application state. • Press in the Chart application to exit cursor mode and centre the vessel on-screen. • Press in the Sonar or DownVision applications to resume scrolling from a paused state. • From the top level application state (Motion mode or Scrolling mode) press once to open the View switcher (DVS and Pro variants only).
5	Power / Shortcuts page button <ul style="list-style-type: none"> • Press once to power the unit on. • When turned on, pressing the power button will display the Shortcuts page. • Press and hold to turn the display off.
6	MicroSD card reader – open the chart reader cover to insert or remove a MicroSD card. The card reader can be used for software updates, electronic charts and archiving data and user settings. <div style="border: 1px solid black; padding: 5px; margin-top: 10px;"> <p>Note: Electronic cartography can only be used with the Pro and M variants.</p> </div>

7.2 Switching the unit on and off

Powering the unit on

1. Press and hold the **Power** button for approximately 3 seconds to power up the unit.
 - * On display products after approximately 5 seconds the splash screen is displayed.
2. * Press **OK** to accept the Limitations of Use disclaimer when it appears.

Note: * Does not apply to **Wi-Fish™**.

Powering the unit off

1. Press and hold the **Power** button for approximately 6 seconds.

On display products a 3 second count-down timer will be displayed.

To cancel the power off process, release the power button before the unit powers off.

Note: The unit will still draw a small amount of power from the battery when powered off, if this is a concern unplug the connector from the back of the unit.

Low voltage warning

A warning message is displayed when the product's voltage supply drops below 10 V dc; the warning will clear automatically when the voltage supply raises above 11 V dc. The product may not operate correctly when the supply voltage is outside of the specified operating voltage range. Please refer to the product's Technical specification for power specification limits.

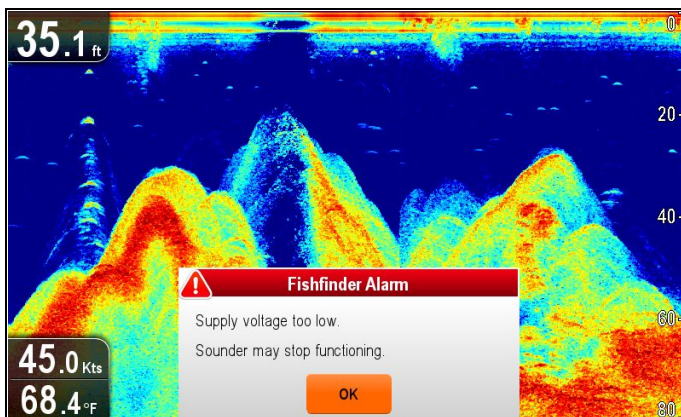

7.3 Initial set up procedures

Once your display has been installed and commissioned, it is recommended that you go through the initial startup wizard and tutorial.

Startup wizard

When you power-up the display for the first time or after a system reset, the Startup Wizard is displayed after you have accepted the Limitations On Use disclaimer. The Startup Wizard guides you through the following initial settings:

1. Language selection.
2. Configure units.
3. Finish / Tutorial.

Note: These settings can also be set at any time using the System Settings menu accessible from the Tools & Settings page.

Additional tasks

In addition to the settings covered by the Wizard, it is also recommended that the following tasks are completed:

- Set your date and time preferences (if applicable).
- Set your transducer depth offset (if applicable).
- Familiarize yourself with the product using Simulator Mode.

Accessing the system settings menu

Depending on display variant, the **System Settings** menu can be accessed by:

- selecting **System Settings** from the **Tools & Settings** page (**DVS** and **Pro**), or by
- selecting: **Menu > System Settings** from the application menu (**DV** and **5 M**).

Setting time and date preferences

Units that include an internal GNSS (GPS/GLONASS) receiver can timestamp waypoints and tracks with the date and time in your preferred format. Fishfinder only products do not include date and time settings.

From the **System Settings** menu:

1. Select **Time and Date Set-up**.
2. Use the **Date Format**, **Time Format**, and **Local Time**: menu items to set your time and date preferences.

Depth Offset

Depths are measured from the transducer to the sea bed, but you can apply an offset value to the depth data, so that the displayed depth reading represents the depth to the sea bed from either the keel or the waterline.

Before attempting to set a waterline or keel offset, find out the vertical separation between the transducer and either the waterline or the bottom of the keel on your vessel, as appropriate. Then set the appropriate depth offset value.

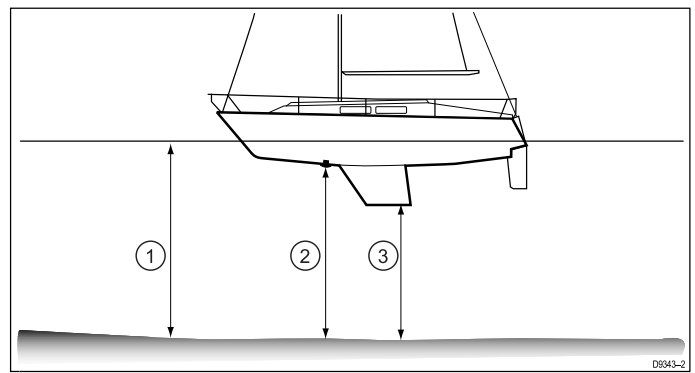

1	Waterline offset
2	Transducer / Zero offset
3	Keel offset

If an offset is not applied, displayed depth readings represent the distance from the transducer to the sea bed.

Setting the depth offset

On Fishfinder products you must apply an offset value for depth readings.

From the **System Settings** menu:

1. Select **Sonar Set-up**.
2. Select **Depth Offset**.
The depth offset numeric adjust control is displayed.
3. Adjust the offset to the required value.
4. Select **Ok** to confirm the new value and close the numeric adjust control.

Simulator mode

The Simulator mode enables you to practice operating your display without data from the GPS receiver or transducer.

The simulator mode is switched on / off in the **System Settings** menu.

Note: Raymarine recommends that you do NOT use the simulator mode whilst navigating.

Note: The simulator will NOT display any real data. This includes safety messages.

Enabling and disabling simulator mode

You can enable and disable simulator mode by following the steps below.

From the **System Settings** menu:

1. Select **Simulator**:
2. Select On to turn simulator mode on, or
3. Select Off to turn simulator mode off.

Note: The Demo movie option is for retail demonstration purposes only.

7.4 Satellite-based navigation

GPS Status

Products with an internal GPS receiver or GNSS (GPS/GLONASS) receiver can use the GPS status page to view the status of the available satellites that are compatible with your receiver.

The satellite constellations are used to position your boat in the Chart application. You can set up your receiver and check its status from the **GPS Set-up** menu. For each satellite, the screen provides the following information:

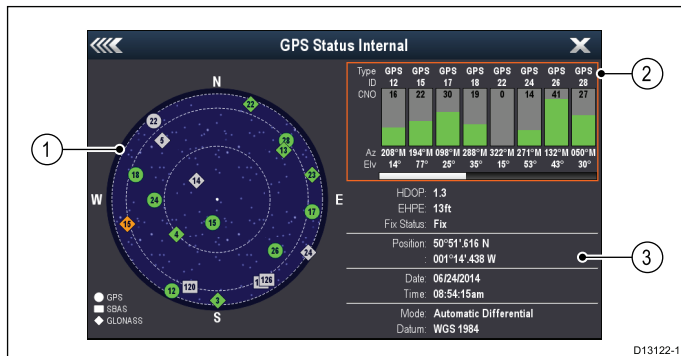

1. Sky view
2. Satellite status
3. Position and fix information

Sky view

Sky view is a visual representation that shows the position of navigation satellites and their type. Satellite types are:

- **Circle** — A circle identifies a satellite from the GPS constellation.
- **Square** — A square identifies a satellite from the SBAS differential satellite.
- **Diamond** — A diamond identifies a satellite from the GLONASS constellation.

Satellite status area

The Satellite status area displays the following information about each satellite:

- **Type** — Identifies which constellation the satellite belongs to.
- **ID** — Displays the satellite's identification number.
- **CNO** (Carrier-to-noise ratio) — Displays the signal strength of each satellite shown in the Sky view:
 - Grey = searching for satellite
 - Green = satellite in use
 - Orange = tracking satellite
- **Azimuth and Elevation** — Provides the angle of elevation and azimuth between the location of the receiver and the satellite.

Position and fix information

The following positional and fix information is provided:

- **Horizontal Dilution of Precision (HDOP)** — HDOP is a measure of satellite navigation accuracy, calculated from a number of factors including satellite geometry, system errors in the data transmission and system errors in the

receiver. A higher figure signifies a greater positional error. A typical receiver has an accuracy of between 5 and 15 m. As an example, assuming a receiver error of 5 m, an HDOP of 2 would represent an error of approximately 15 m. Please remember that even a very low HDOP figure is NO guarantee that your receiver is providing an accurate position. If in doubt, check the displayed vessel position in the Chart application against your actual proximity to a known charted object.

- **Estimated Horizontal Position Error (EHPE)** — EHPE is a measure of the estimated error of a position fix in the horizontal plane. The value displayed indicates that your position is within a circle radius of the stated size 50% of the time.
- **Fix status** — indicates the actual mode the receiver is reporting:
 - **Fix** — Satellite fix has been acquired.
 - **No Fix** — No satellite fix can be acquired.
 - **D Fix** — A differential beacon fix has been acquired.
 - **SD Fix** — A differential satellite fix has been acquired.
- **Position** — Displays the latitude and longitude position of your receiver.
- **Date / Time** — Displays the current date and time generated by the position fix in UTC format .
- **Mode** — Identifies whether the receiver is working in differential mode or non-differential mode.
- **Datum** — The receiver's datum setting affects the accuracy of the vessel position information displayed in the Chart application. In order for your receiver and MFD to correlate accurately with your paper charts, they must be using the same datum.

Checking GPS operation

You can check that the GPS is functioning correctly using the Chart application.

1. Open the Chart application.



2. Check the screen.

You should see:

Your vessel position (indicates a GPS fix). Your current position is represented by a vessel symbol or solid circle.

A solid circle on the chart indicates that the vessel speed is too low (i.e. less than 0.15 kts) to provide Course Over Ground (COG) data.

Note: It is recommended that you check the displayed vessel position in the Chart application against your actual proximity to a known charted object. GNSS receivers typically have an accuracy of between 5 m and 15 m.

Note: A GPS Status screen provides satellite signal strength and other relevant information.

7.5 Checking the sonar application

Products which include the Sonar application and the **CPT-DVS** transducer can use the Sonar application to help target fish.

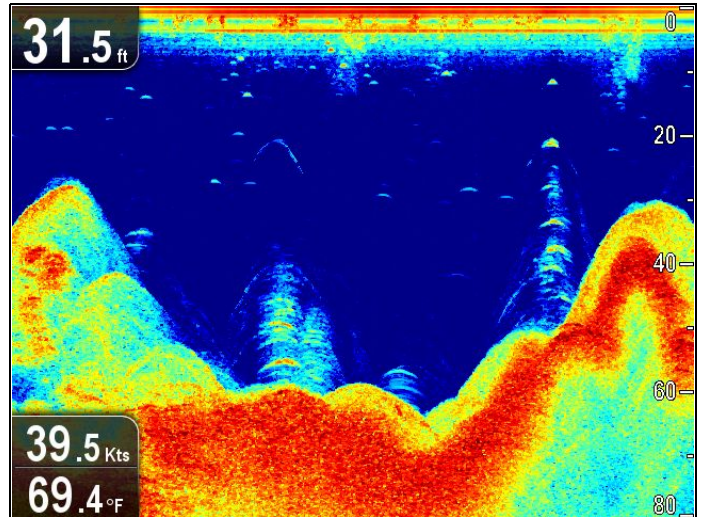

From the Sonar application:

1. Check the display.

With the transducer active you should see a scrolling (left to right) image that shows the bottom and underwater structure, you should also see a depth reading in the top left databox.

7.6 Checking the DownVision™ application

Products which include the **DownVision™** application and the **CPT-DV** or **CPT-DVS** transducer can use the **DownVision™** application to display underwater structure and objects.

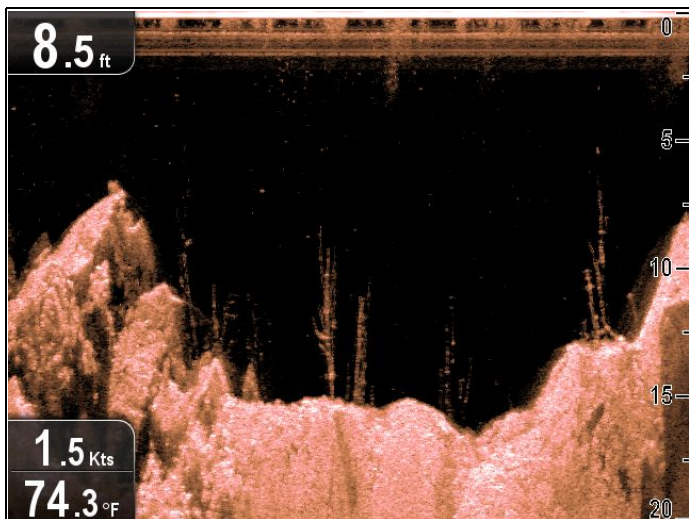

From the **DownVision™** application:

1. Check the display.

With the transducer active you should see a scrolling (left to right) image that shows the bottom structure, you should also see a depth reading in the top left databox.

7.7 Shortcuts page

The shortcuts page provides access to the following functions:

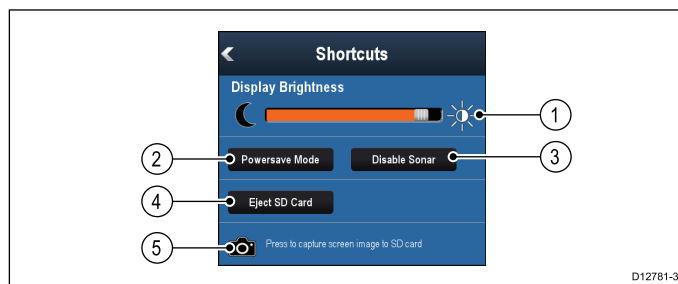

1	Brightness control.
2	PowerSave mode — selecting will activate PowerSave mode.
3	Enable / Disable Sonar — selecting will enable or disable the internal sonar and DownVision.
4	Eject SD card — select to safely remove the memory card.
5	Screen capture — selecting saves a screenshot to memory card.

Opening the shortcuts page

With the display powered on:

1. Press the **Power** button once.
The shortcuts page is displayed.
2. Use the **Directional controls** to highlight an option.
3. Press the **OK** button to select the option.

Adjusting the display brightness

1. Press the **POWER** button once.
The Shortcuts page is displayed.
2. Adjust the brightness to the required level using the **Track pad**.

Note: The brightness level can also be increased by pressing the **Power** button multiple times.

PowerSave mode

In PowerSave mode all functions of the product remain active, but the display is placed into a low power state. PowerSave mode is cancelled by pressing a physical button or when an alarm event occurs.

Enabling PowerSave mode

To enable PowerSave mode follow the steps below.

1. Press the **POWER** button.
The shortcuts menu is displayed.
2. Select **PowerSave Mode**.
The display is now in PowerSave mode.
3. You can wake the display from PowerSave mode at anytime by pressing a physical button.

Note: PowerSave mode is automatically cancelled if an alarm event occurs.

Disabling and enabling the Sonar

The transducer ping can be disabled and enabled from the shortcuts page.

1. Select **Disable Sonar** to stop the transducer pinging.
2. Select **Enable Sonar** to start the transducer pinging.

Note:

- When enabled, the sonar element will ping if the view displayed contains the Sonar application or the Chart application
- When enabled, the **DownVision™** element will ping only if the view displayed includes the **DownVision™** application.

Screenshots

You can take a screenshot of what is currently displayed on the screen.

Screenshots are saved in .png (Portable Network Graphic) format to a MicroSD Card. The saved images can be viewed from any device capable of viewing .png images.

Taking a screenshot





You can take a screenshot by following the steps below.

1. Insert a MicroSD card with suitable free space into the card reader.
2. Press the **Power** button.
The Shortcuts page is displayed:
3. Select the **Camera** icon.
A confirmation message is displayed.
4. Select **OK**.
The screenshot is now saved to the MicroSD card.

Tip If your display has a **Back** button you can also take a screenshot by pressing and holding the **Back** button until the confirmation message appears.

7.8 Applications

The applications available on your display are dependent upon product variant.

	Description	Applicable Products
	Chart application — provides a 2D graphical view of your charts to help you navigate. Waypoint and track functions enable you to navigate to a specific location or record where you've been. Chart cards provide higher levels of detail.	<ul style="list-style-type: none"> • Pro • M
	Sonar application — this application uses CHIRP processing to help you target fish beneath your vessel. You can also view water depth, water temperature and mark points of interest such as fishing spots or wrecks.	<ul style="list-style-type: none"> • DVS • Pro
	DownVision application — this application gives increased coverage either side of the vessel in high definition. CHIRP processing and higher operating frequency allows greater depth resolution, making it easier to identify bottom structures around which fish may reside. You can also view water depth, water temperature and mark points of interest such as fishing spots or wrecks.	<ul style="list-style-type: none"> • DV • DVS • Pro
	Tools & Settings — provides access to alarms, system settings, backup and reset features.	<ul style="list-style-type: none"> • DVS • Pro

7.9 View switcher

Products that include more than 1 application use the **View Switcher** to cycle through available views. Fullscreen and splitscreen application views are available.

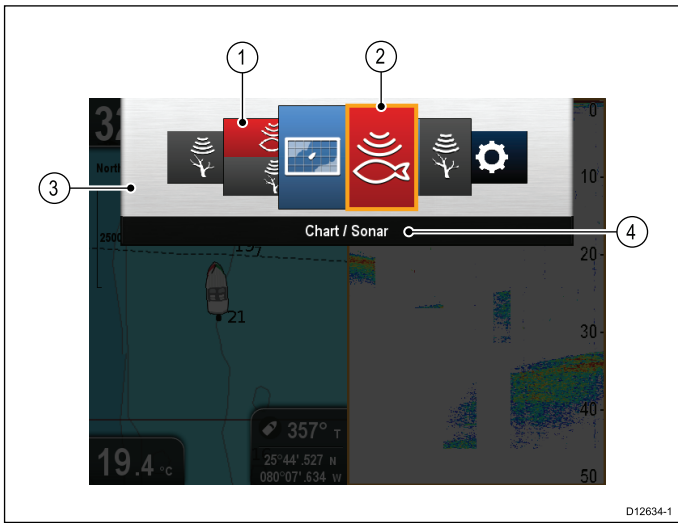

1	View thumbnails
2	Active application
3	View switcher
4	View switcher titlebar

The views available are dependent on product variant but can include:

- Chart application
- Sonar application
- DownVision application
- DownVision / Sonar application — splitscreen
- Chart application / Sonar application — splitscreen
- Chart application / DownVision application — splitscreen
- Tools & Settings

Opening the View switcher

From the top level application state (Motion mode or Scrolling mode):

1. Press the **Back** button.

Using the View switcher

To select a view follow the steps below.

With the View switcher displayed:

1. Use the **Directional controls** to highlight a view.
2. Press the **OK** button to display the chosen view.

Selecting the active pane in splitscreen views

When a splitscreen view is displayed you can change the active pane (the pane that you want to control) using the View switcher.

With a splitscreen view displayed.

1. If required press the **Back** button to change the Chart application to Motion mode, or the Sonar and DownVision applications to Scrolling mode.

2. Press the **Back** button again.
The View switcher is displayed.
3. Use the **Directional controls** to highlight the pane you want to make active.
4. Press the **OK** button to confirm.
The selected view is displayed and a border is placed around the active pane.

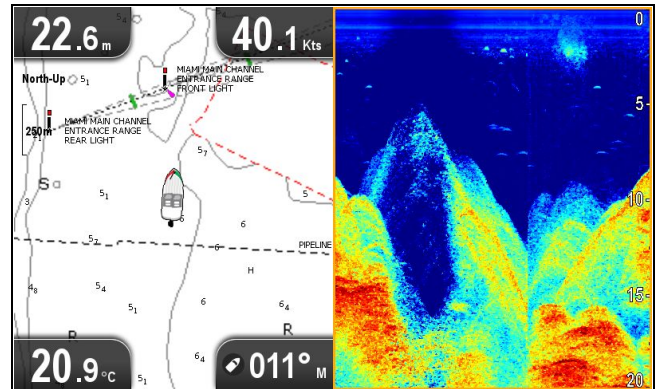

7.10 Memory cards and chart cards

MicroSD memory cards can be used to back up / archive data (e.g. Waypoint, and Tracks). Once data is backed up to a memory card old data can be deleted from the system, creating capacity for new data. The archived data can be retrieved at any time. Chart cards provide additional or upgraded cartography.

It is recommended that your data is backed up to a memory card on a regular basis. Do NOT save data to a memory card containing cartography.

Compatible cards

The following types of MicroSD cards are compatible with your display:

- Micro Secure Digital Standard-Capacity (MicroSDSC)
- Micro Secure Digital High-Capacity (MicroSDHC)

Note:

- The maximum supported memory card capacity is 32 GB.
- MicroSD cards must be formatted to use either the FAT or FAT 32 file system format to enable use with your MFD.

Speed class rating

For best performance it is recommended that you use Class 10 or UHS (Ultra High Speed) class memory cards.

Chart cards

Your product is pre-loaded with electronic charts (worldwide base map). If you wish to use different chart data, you can insert compatible chart cards into the unit's memory card reader.

Use branded chart cards and memory cards

When archiving data or creating an electronic chart card, Raymarine recommends the use of quality branded memory cards. Some brands of memory card may not work in your unit. Please contact customer support for a list of recommended cards.

Removing MicroSD card from its adaptor

MicroSD memory and cartography chart cards are usually supplied inserted into an SD card adaptor. The card will need to be removed from the adaptor before inserting into your display.

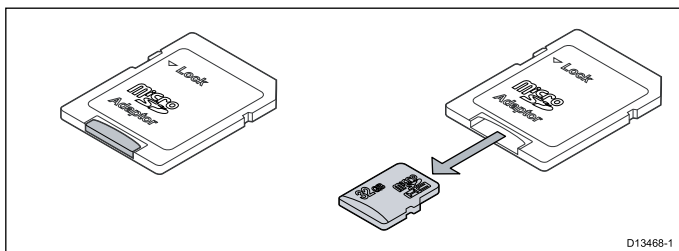

Caution: Care of chart and memory cards

To avoid irreparable damage to and / or loss of data from chart and memory cards:

- DO NOT save data or files to a card containing cartography as the charts may be overwritten.
- Ensure that chart and memory cards are fitted the correct way around. DO NOT try to force a card into position.
- DO NOT use a metallic instrument such as a screwdriver or pliers to insert or remove a chart or memory card.

Opening the MicroSD card reader cover

The MicroSD card reader is located on the rear of the unit. The card reader is protected by a weatherproof cover.

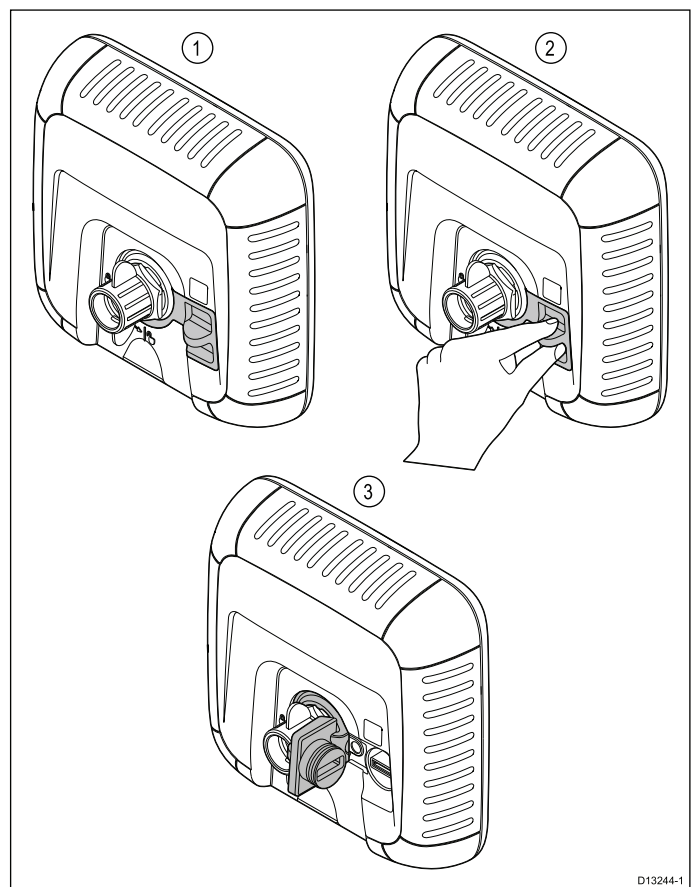

1. Cover closed
2. Opening cover
3. Cover open

1. Open the card reader cover by pulling backwards on the cover's handle until the cover is positioned as shown in (3) above.

The cover has a tight fit and may require some force to open the cover.

2. Fully close the card reader cover.

Important: When closing the cover ensure that it is fully pushed in and sealed all the way around the edge, this will provide the weatherproof seal.

Inserting a MicroSD card

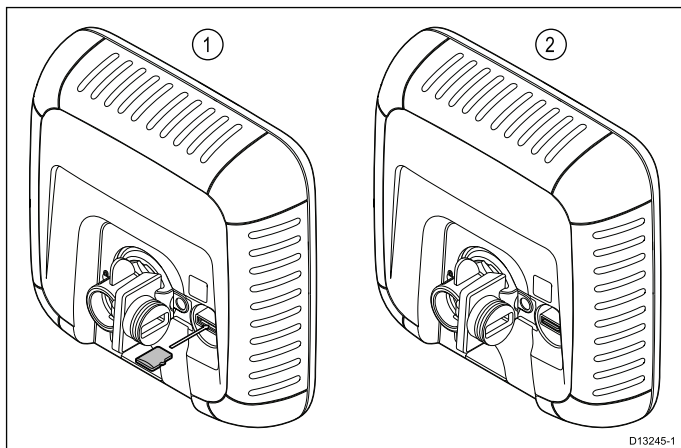

With the card reader's cover open:

1. Insert the card with the contacts facing down.
2. Gently press the MicroSD card all the way into the card reader slot.
3. Fully close the card reader cover.

Important: When closing the cover ensure that it is fully pushed in and sealed all the way around the edge, this will provide the weatherproof seal.

Removing a MicroSD card

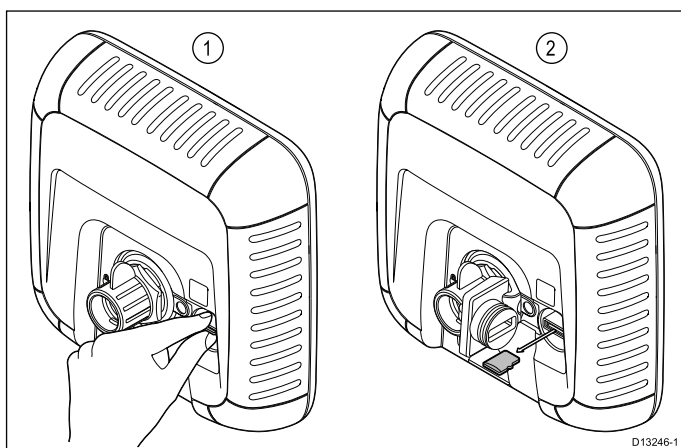

1. On display products select **Eject SD Card** from the Shortcuts page.
2. Open the card reader's cover.
3. Pinch the protruding edge of the MicroSD card between your index finger and thumb and pull the card clear of the card reader slot.
4. Fully close the card reader cover.

Important: When closing the cover ensure that it is fully pushed in and sealed all the way around the edge, this will provide the weatherproof seal.

7.11 Learning resources

Raymarine has produced a range of learning resources to help you get the most out of your products.

Video tutorials

	<p>Raymarine official channel on YouTube:</p> <ul style="list-style-type: none"> • http://www.youtube.com/user/RaymarineInc
	<p>Video Gallery:</p> <ul style="list-style-type: none"> • http://www.raymarine.co.uk/view/?id=2679
	<p>Product Support videos:</p> <ul style="list-style-type: none"> • http://www.raymarine.co.uk/view/?id=4952

Note:

- Viewing the videos requires a device with an Internet connection.
- Some videos are only available in English.

Training courses

Raymarine regularly runs a range of in-depth training courses to help you make the most of your products. Visit the Training section of the Raymarine website for more information:

- <http://www.raymarine.co.uk/view/?id=2372>

FAQs and Knowledge Base

Raymarine has produced an extensive set of FAQs and a Knowledge Base to help you find more information and troubleshoot any issues.

- <http://www.raymarine.co.uk/knowledgebase/>

Technical support forum

You can use the Technical support forum to ask a technical question about a Raymarine product or to find out how other customers are using their Raymarine equipment. The resource is regularly updated with contributions from Raymarine customers and staff:

- <http://raymarine.ning.com/>

Chapter 8: Fishfinder applications

Chapter contents

- 8.1 **DownVision™** application overview on page 60
- 8.2 Sonar application overview on page 60
- 8.3 Fishfinder applications' features on page 62
- 8.4 Fishfinder applications' controls on page 62
- 8.5 Zoom on page 63
- 8.6 Range on page 64
- 8.7 Scrolling on page 64
- 8.8 A-Scope mode on page 65
- 8.9 Display Options on page 65
- 8.10 Colors on page 66
- 8.11 Sensitivity adjustments on page 67
- 8.12 **DV** System settings menu options on page 68

8.1 DownVision™ application overview

The **DownVision™** application uses a compatible transducer to produce a detailed structure view of the water column beneath your vessel. This enables you to accurately distinguish bottom structure, and underwater objects. **DownVision™** uses **CHIRP** processing with a centered 350 KHz ping frequency, which provides a higher resolution image than the Sonar application.

The **DownVision™** application displays a scrolling image which scrolls from right to left across the screen.

The **DownVision™** application uses monochrome palettes and shading to differentiate between target strengths.

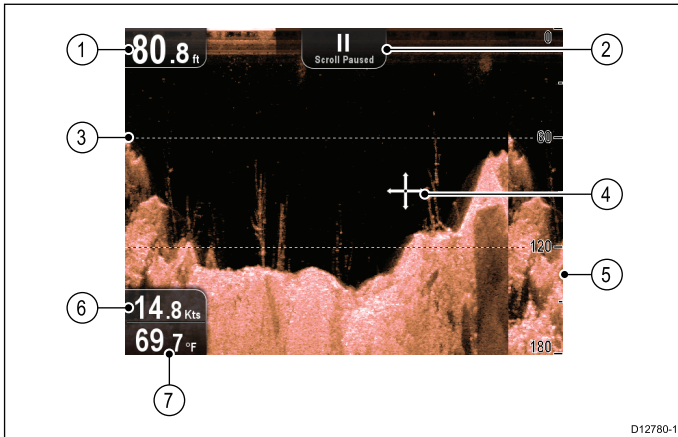

1	Depth reading — Current depth of the bottom.
2	Scrolling paused — Scrolling pauses when the Joystick is used to move the cursor around the screen).
3	Depth lines — Horizontal dashed lines drawn at regular intervals to indicate the depth from the surface.
4	Cursor — Displayed in cursor mode.
5	Depth markers — These numbers indicate depth.
6	Speed — Current vessel Speed Over Ground (SOG). Only applicable to displays with GPS / GNSS receivers
7	Water temperature — Current water temperature.

8.2 Sonar application overview

The Sonar application uses a compatible transducer to produce a detailed view of fish and the water column including bottom under your vessel. This enables you to accurately distinguish between different sizes of fish, bottom structure, and underwater objects. The Sonar application uses **CHIRP** processing with a centered 200 KHz ping frequency, which provides a greater depth range than **DownVision™** but less detail.

The Sonar application displays a scrolling image which scrolls from right to left across the screen.

The Sonar application uses different colors to differentiate target strengths. The colors used are dependent upon the selected color palette (e.g. the classic blue color palette uses blue to identify the weakest targets and red for the strongest).

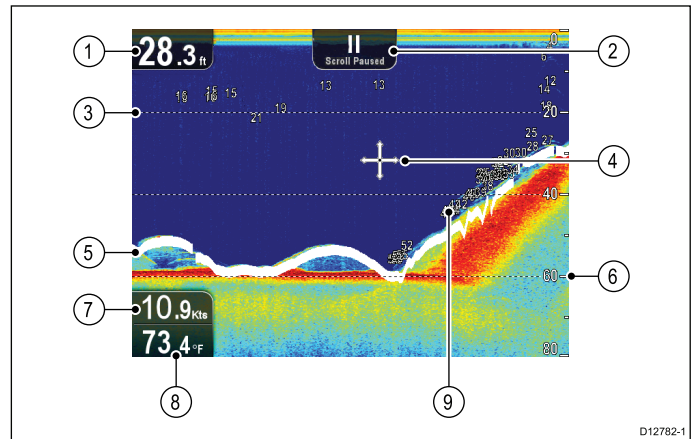

1	Depth reading — Current bottom depth.
2	Scrolling paused — Scrolling pauses when the Joystick is used to move the cursor around the screen).
3	Depth lines — Horizontal dashed lines drawn at regular intervals to indicate the depth from the surface.
4	Cursor — Displayed in cursor mode.
5	Bottom line — Displays a thick line to identify the bottom.
6	Depth markers — These numbers indicate depth.
7	Speed — Current vessel Speed Over Ground (SOG). Only applicable to displays with GPS / GNSS receivers
8	Water temperature — Current water temperature.
9	Depth Target ID — Depths are displayed against recognized targets. The sensitivity of these IDs is directly linked to the Fish Alarm sensitivity; the greater the fish alarm sensitivity, the greater the number of labelled returns.

The sonar image

Interpreting the bottom using sonar

It is important to understand how to correctly interpret the bottom structure represented on-screen.

The bottom usually produces a strong echo.

The following images show how different bottom conditions are represented on-screen:

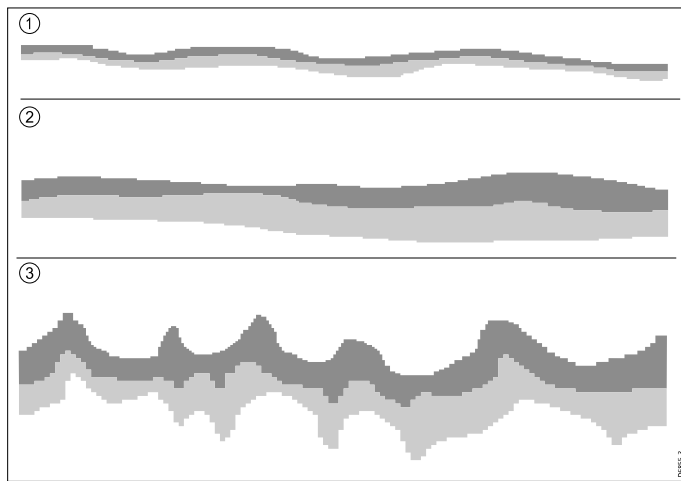

Item	Description
1	A hard bottom (sand) produces a thin line.
2	A soft bottom (mud or seaweed cover) produces a wide line.
3	A rocky or uneven bottom or a wreck produces an irregular image with peaks and troughs.

The dark layers indicate a good echo; the lighter areas indicate weaker echoes. This could mean that the upper layer is soft and therefore allowing sound waves to pass to the more solid layer below.

It is also possible that the sound waves are making two complete trips – hitting the bottom, bouncing off the vessel, then reflecting off the bottom again. This can happen if the water is shallow or the bottom is hard.

Factors influencing the sonar image

The quality and accuracy of the display can be influenced by a number of factors including vessel speed, depth, object size and background noise.

Vessel speed

The shape of the target changes along with your speed. Slower speeds return flatter, more horizontal marks. Higher speeds cause the target to thicken and arch slightly, at fast speeds the mark resembles a double vertical line.

Target depth

The closer the target to the surface, the larger the mark on screen.

The depth of individual targets can be displayed by switching on the **Target Depth ID** in the sonar menu **Menu > Display Options**. The number of target depths displayed is influenced by the fish alarm sensitivity level.

Water depth

As water depth increases signal strength decreases, resulting in a lighter on-screen image of the bottom.

Size of the target

The larger the target, the larger the return on-screen. The size of a fish target is also dependent upon the size of the fish's swim bladder rather than its overall size. The swim bladder varies in size between different breeds of fish.

Clutter / Background noise

The sonar image may be impaired by echoes received from floating or submerged debris, particulate matter (such as plankton, phytoplankton, or silt etc.), air bubbles or even the vessel's movement. This is known as 'background noise' or 'clutter' and is controlled by the Sensitivity settings. If required you can adjust the setting manually.

8.3 Fishfinder applications' features

Using waypoints to mark fishing spots or target locations (Pro only)	<ul style="list-style-type: none"> • Placing a waypoint
Determining target depths.	<ul style="list-style-type: none"> • Enabling / Disabling Target Depth ID • Enabling / Disabling Depth Lines
Adjusting the speed of the scrolling image.	<ul style="list-style-type: none"> • 8.7 Scrolling
Setting alarms (fish, depth or water temperature).	<ul style="list-style-type: none"> • 11.2 Alarms
Using Zoom.	<ul style="list-style-type: none"> • 8.5 Zoom
* Using A-Scope mode.	<ul style="list-style-type: none"> • 8.8 A-Scope mode
Changing the on-screen depth range.	<ul style="list-style-type: none"> • 8.6 Range
Adjusting Sensitivity Settings to help optimize and simplify the displayed image.	<ul style="list-style-type: none"> • 8.11 Sensitivity adjustments

Note: * Not available in DownVision application.

8.4 Fishfinder applications' controls

The Sonar applications consists of 2 modes: **Scrolling mode** and **Cursor / Pause mode**. The behavior of some controls are dependent upon mode and product variant.

Scrolling mode

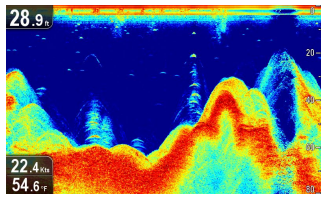
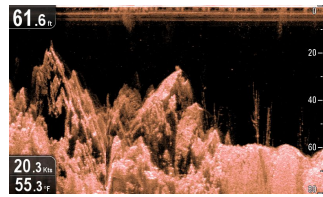
Sonar application	DownVision™ application
	

Scrolling mode is the default mode. In **Scrolling mode** an image is displayed which scrolls from right to left across the screen.

In **Scrolling mode** the controls behave as follows:

- from the default view, pressing the **+** button enables Zoom mode.
 - when in Zoom mode use **+** and **–** buttons to increase or decrease the zoom level.
- pressing the **OK** button opens the application menu.
- pressing the **Back** button opens the **View switcher** (not applicable to **DV** variants).
- using any of the **Directional controls** will switch to **Cursor / Pause mode**.

Cursor / Pause mode

Important: The **DV** and **DVS** variants do not display a cursor in **Cursor / Pause mode**.

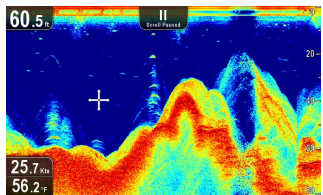
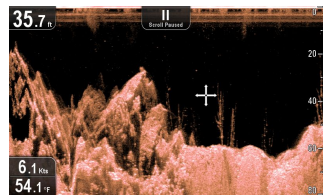
Sonar application	DownVision™ application
	

In **Cursor / Pause mode** the scrolling image is paused and depending on product variant, the cursor can be moved around the screen.

In **Cursor / Pause mode** the controls behave as follows:

- from the default view, pressing the **+** button enables Zoom mode.
 - when in Zoom mode use **+** and **–** buttons to increase or decrease the zoom factor.
- using any of the **Directional controls** will move the cursor in that direction (not applicable to **DV** and **DVS** variants).
- pressing the **Ok** button opens the context menu.
- pressing the **Back** button returns the application to **Scrolling mode**.

Menus and dialogs

With a menu or dialog open the controls behave as follows:

- The **Directional controls** can be used to scroll through the available menu options.
- Pressing the **Ok** button selects the highlighted option or confirms and dismisses pop up messages.
- pressing the **Back** button returns to the previous menu or closes the menu.

Placing a waypoint

Displays with a GPS / GNSS receiver can use waypoints to mark points of interest.

1. Use the **Directional controls** to highlight the desired location with the cursor.
2. Press the **OK** button.
The context menu is displayed.
3. Select **Place Waypoint**.
A confirmation pop up message is displayed.
4. Select **Ok** to place the waypoint, or **Edit** to edit the waypoint details.

A waypoint is placed at the cursor's location.

Context menu

A context menu is available on displays with a GPS / GNSS receiver, which provides data and shortcuts to menu items.



The context menu provides the position of the cursor:

- Depth
- Range

The context menu also provides the following menu items:

- **Place Waypoint**

Accessing the context menu

You can access the context menu by following the steps below.

1. Use the **Directional controls** to highlight an object or area.
2. Press the **OK** button.
The context menu is displayed.

8.5 Zoom

The Zoom function displays more detail onscreen by magnifying a specific area of the image.

When using Zoom the screen is split and displays the zoomed image alongside the standard image.

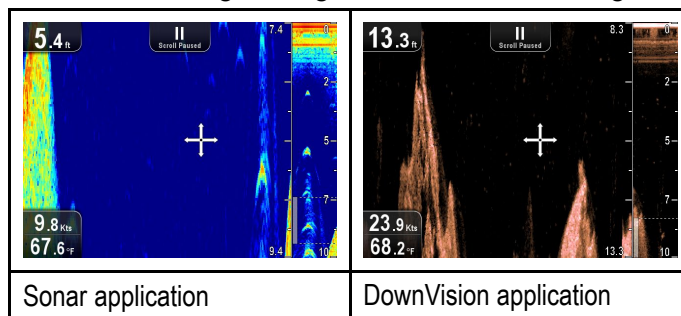

This enables you to:

- select an area from the standard view that is magnified and displayed alongside.
- increase and decrease the zoom level.

The zoomed section is indicated on the standard screen by the zoom box.

Adjusting the Zoom level

To adjust the Zoom level and area follow the steps below.

With the standard view displayed:

1. Pressing the **+** button to enable Zoom mode.
2. Subsequent presses of the **+** button will increase the Zoom level
3. Pressing the **-** button will decrease the Zoom level and finally revert to the standard view.

Selecting a Zoom area

When using Zoom the area displayed in the magnified area of the screen can be changed.

With Zoom enabled:

1. Use the **Up** and **Down Directional controls** to move the magnified area up and down through the water column.

8.6 Range

The **Range** function enables you to change the range of depth displayed onscreen. Where applicable changes to the Range will apply to both the Sonar and **DownVision™** applications.

By default, the Range is set to automatic, this adjusts the Range to ensure the bottom is always displayed onscreen. This is useful for targeting bigger fish and other objects located closer to the bottom such as wrecks

Manual Range allows you to specify a Shallow range depth and Deep range depth which defines the area displayed onscreen.

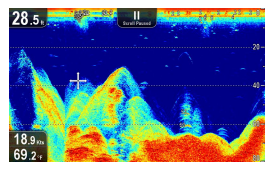
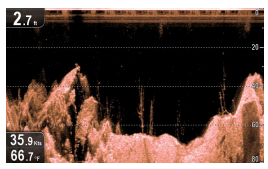
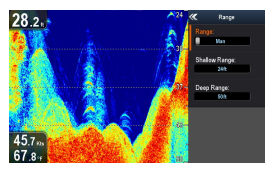
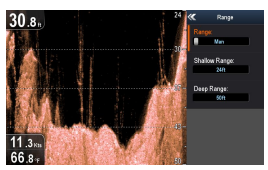
	Sonar application	DownVision™ application
Auto Range		
Manual Range		

Switching between Auto and Manual range

From the application menu:

1. Select **Range**.
2. Select **Range:** to switch between Auto and Man.
3. With manual mode selected you can now adjust the depth range shown onscreen.

Manually adjusting range

To specify the area of depth to be displayed onscreen follow the steps below.

From the application menu:

1. Select **Range**.
2. Select **Range:** so that Man is selected.
3. Select **Shallow Range**.

The **Shallow Range** defines the depth that will be shown at the top of the screen.

4. Adjust the **Shallow Range** to the required depth.
5. Select **Deep Range**.

The **Deep Range** defines the depth that will be shown at the bottom of the screen.

6. Adjust the **Deep Range** to the required depth.

8.7 Scrolling

The image scrolls from right to left. The scroll speed can be adjusted to help with target identification. The scrolling can be paused by entering Cursor mode.

Scroll speed

The default scrolling speed is 100%. The scroll speed can be slowed down to 10% of the default speed.

Adjusting the scroll speed

From the **Display Options** menu:

1. Select **Scroll Speed**.
The Scroll speed adjustment control is displayed.
2. Use the **Up** and **Down Directional controls** to adjust the scroll speed between 10% and 100%.
3. Press the **Ok** or **Back** button to confirm and close the adjustment control.

8.8 A-Scope mode

A-Scope mode is available in the Sonar application only. A-Scope mode displays a splitscreen showing the standard view alongside a live image of the water column directly beneath the transducer.

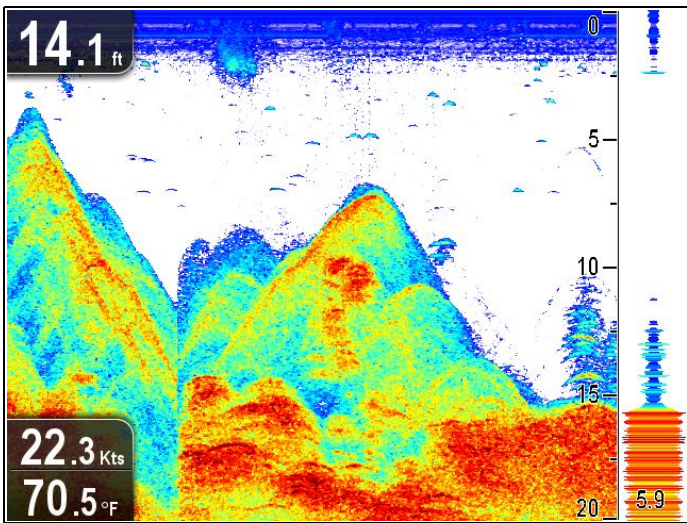

The area covered by the A-Scope is indicated at the bottom of the window. A-Scope provides a more precise and easier to interpret indication of the target strength.

Switching between A-Scope and Standard view

You can switch between the standard view and A-Scope mode at any time following the steps below.

With the standard view displayed in the Sonar application:

1. Select **Menu**.
2. Select **Display Options**.
3. Select **A-Scope**.

Selecting **A-Scope**: will switch A-Scope mode On and Off.

Note: If Zoom mode is enabled, The screen will not show the A-Scope until the Zoom has been disabled.

8.9 Display Options

The application can be customized using the **Display Options** menu.

The display options can be used to overlay additional depth features and manipulate the image to enable easier fish targeting.

Available depth features:

- **Target Depth ID** — Not available in **DownVision™** application
- **Depth Lines**
- **White Line** — Not available in **DownVision™** application

Enabling / Disabling Target Depth ID

You can display the depth of targets on-screen.

From the application menu:

1. Select **Display Options**.
2. Select **Target Depth ID**.

Selecting Target Depth ID will switch the target depth indicator On and Off.

Note: The strength of targets which display a depth ID is related to the Fish sensitivity setting, accessible from the Alarms menu.

Enabling / Disabling Depth Lines

You can display horizontal depth lines on-screen.

From the application menu:

1. Select **Display Options**.
2. Select **Depth Lines**.

Selecting Depth Lines will switch the horizontal depth lines On and Off.

Enabling / Disabling the White Line

You can display a thick line on-screen to represent the bottom, this line is primarily white in color (depending upon color palette chosen).

From the application menu:

1. Select **Display Options**.
2. Select **White Line**.

Selecting White Line will switch the bottom line On and Off.

8.10 Colors

Various color palettes are available to suit different conditions and your personal preference.

The new color palette remains selected after a power cycle, The color palette is a global setting which will apply to all views.

Sonar application color palettes

Classic Blue (default)	
Classic Black	
Classic White	
Sunburst	
Night Vision	

DownVision™ application color palettes

Copper	
Inv. Copper	
Slate Gray	
Inv. Slate Gray	

Selecting colors

The Colors used can be changed at any time by selecting an option from the relevant menu:

- **Menu > Display Options > Color Palette (DV variants)**
- **Menu > Display Options > Sonar Colors (DVS and Pro variants)**
- **Menu > Display Options > DownVision Colors (DVS and Pro variants)**

8.11 Sensitivity adjustments

The onscreen image can be enhanced using the Sensitivity settings.

Sensitivity options are:

- **Gain**
- **Contrast**
- **Noise Filter**

Gain

The Gain setting adjusts the return threshold (echo strength) at which an object will be displayed onscreen. Adjusting the setting can improve target identification, however for optimum performance in most conditions, it is recommended that you use the auto setting.

Gain can be set to automatic or manual:

- **Automatic** — In Auto mode, the setting is automatically adjusted to suit current conditions. Any adjustments made apply to all views using that application.
- **Manual** — If necessary you can adjust the setting manually, between a value of 0% to 100%. The higher the setting the more detail will appear onscreen. This value should be set high enough to see fish and bottom detail without too much background noise. Generally a higher setting is used in deep and/or clear water; a low setting in shallow and/or murky water.

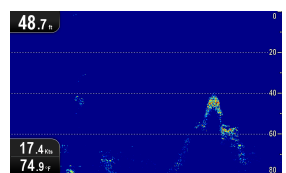
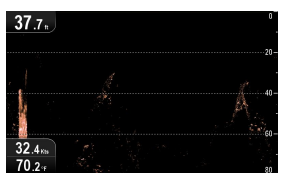
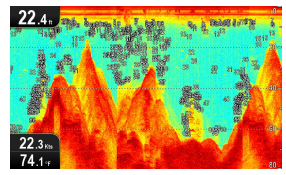
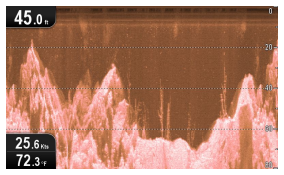
	Sonar	DownVision
40%		
100%		

The new values will persist over a power cycle.

Adjusting Gain

From the application menu:

1. Select **Sonar Sensitivity** or **DownVision Sensitivity**.
2. Select **Gain**.
3. Use the **Up** and **Down Directional controls** to adjust the Gain setting to the required value, or
4. Press the **OK** button to switch between Auto and Manual.

Contrast

The Contrast setting changes the signal strength threshold for the strongest color / shading. Adjusting the setting can improve target identification, however for optimum performance in most conditions, it is recommended that you use the auto setting.

All echoes with a signal strength above the specified value are displayed in the strongest color / shade. Those with a weaker value are divided equally between the remaining colors / shades.

- Setting a low value produces a wide band for the weakest color / shade, but a small signal band for the other colors / shades.
- Setting a high value gives a wide band for the strongest color / shade, but a small signal band for the other colors / shades.

The Contrast setting can be set to automatic or manual:

- **Automatic** — In Auto mode the contrast setting is automatically adjusted to suit current conditions. Any adjustments made apply to all views.
- **Manual** — You can set the contrast manually, between a value of 0% to 100%.

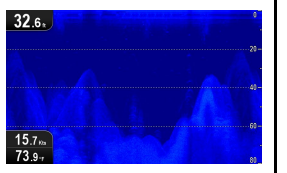
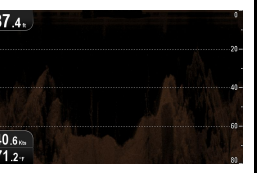
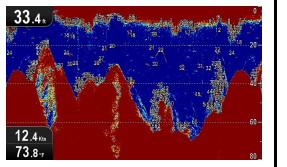
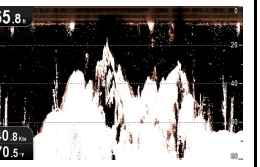
	Sonar	DownVision
0%		
100%		

The new values will persist over a power cycle.

Adjusting the Contrast

From the application menu:

1. Select **Sonar Sensitivity** or **DownVision Sensitivity**.
2. Select **Contrast**.
3. Use the **Up** and **Down Directional controls** to adjust the Contrast to the required value, or
4. Press the **OK** button to switch between Auto and Manual.

Noise Filter

The Noise Filter reduces the amount of clutter displayed onscreen by varying the gain throughout the column of water. Adjusting the setting can improve target identification, however for optimum performance in most conditions, it is recommended that you use the auto setting.

The Noise Filter can be set to automatic or adjusted manually:

- **Automatic** — In Auto mode the Noise Filter is set to 20%.
- **Manual** — You can adjust the Noise Filter manually, between a value of 0% to 100%.

- A low value decreases the depth at which the filter is applied.
- A high value increases the depth at which the filter is applied.

8.12 DV System settings menu options

The **System Settings** menu on the **DV** variant display is located in the main application menu.

Refer to [11.1 System Settings menu](#) for details on available options for your display variant.

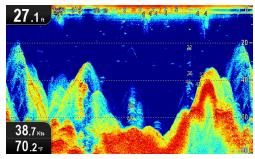
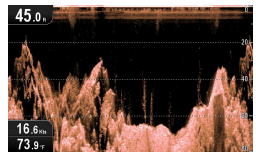
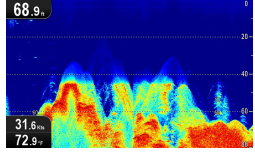
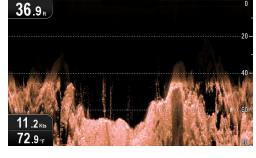
	Sonar	DownVision
0%		
100%		

The new values will persist over a power cycle.

Adjusting the Noise Filter

From the application menu:

1. Select **Sonar Sensitivity** or **DownVision Sensitivity**.
2. Select **Noise Filter**.
3. Use the **Up** and **Down Directional controls** to adjust the Noise Filter to the required value, or
4. Press the **OK** button to switch between Auto and Manual.

Chapter 9: Chart application

Chapter contents

- [9.1 Chart application overview on page 70](#)
- [9.2 Electronic charts overview on page 71](#)
- [9.3 Chart application controls on page 73](#)
- [9.4 Waypoints overview on page 74](#)
- [9.5 Tracks on page 81](#)
- [9.6 Import and Export on page 83](#)
- [9.7 Waypoints and tracks storage capacity on page 84](#)
- [9.8 Navigation on page 84](#)
- [9.9 Chart settings menu — cartography compatibility on page 85](#)
- [9.10 Chart selection on page 86](#)
- [9.11 Chart Detail on page 86](#)
- [9.12 High resolution bathymetry on page 87](#)
- [9.13 Chart orientation on page 87](#)
- [9.14 Text and Symbol size on page 88](#)
- [9.15 Boat position on page 89](#)
- [9.16 Community layer on page 89](#)
- [9.17 Sonar logging on page 90](#)
- [9.18 COG Vector on page 90](#)
- [9.19 Deep Water on page 91](#)
- [9.20 Chart objects on page 91](#)
- [9.21 5 M System settings menu on page 92](#)

9.1 Chart application overview

The Chart application is available on products that include an internal GPS / GNSS receiver. It uses 2D perspective and provides a variety of cartographic information regarding your surroundings and charted objects. The Chart application is pre-loaded with **LightHouse™**, **Navionics®** and **C-MAP by Jeppesen®** world base maps. Compatible electronic charts can be used to expand the information and detail regarding your surroundings and charted objects.

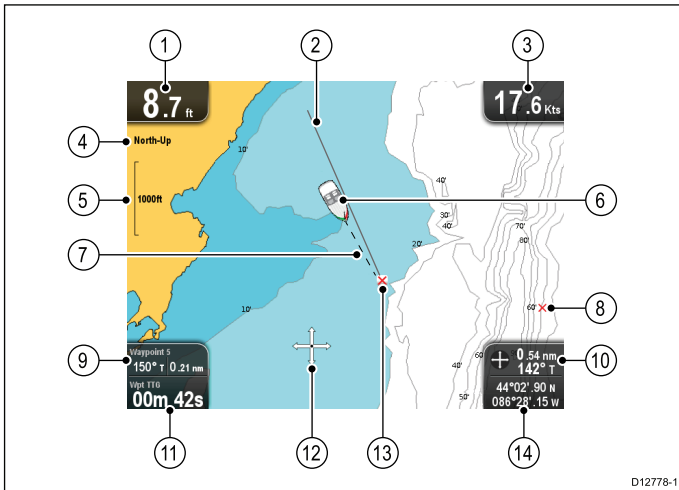

1	Depth — Current water depth (only available with transducer connected).
2	Navigation origin line — During navigation, shows a solid line from the starting point to the target waypoint.
3	Speed — Current vessel speed (shown in selected system units).
4	Orientation — States the orientation mode that the chart is using (North-up, or Course-up).
5	Range — Chart scale indicator (shown in selected system units).
6	Vessel symbol — Shows your current position.
7	Vessel position line — During navigation, shows a dotted line from the vessel's current position to the target waypoint.
8	Waypoint — Inactive.
9	Water temperature — When not in active navigation current water temperature is displayed. Distance to cursor/waypoint — (Applies to Dragonfly-4 and Dragonfly-5) During active navigation the distance to the target is displayed. Bearing and distance to cursor/waypoint — (Applies to Dragonfly-7 only) During active navigation the distance to the target is displayed.
10	Bearing — In motion mode the vessel's current COG bearing is displayed. Cursor bearing and distance — In cursor mode the bearing and distance to the cursor's location, from your vessel is displayed.
11	Waypoint TTG — (Applies to Dragonfly-7 only) During active navigation the estimated 'time to go' to the target cursor/waypoint based on your current speed is displayed.

12	Cursor — Used to select chart objects and move around the chart area.
13	Target waypoint — Current target waypoint.
14	Vessel coordinates — (Applies to Dragonfly-7 only) In motion mode the current vessel coordinates are displayed. Cursor coordinates — (Applies to Dragonfly-7 only) In cursor mode the coordinates of the cursor's location is displayed.

The Chart application includes the following features to help you navigate your vessel safely and effectively:

Features

Using satellite-based navigation.	<ul style="list-style-type: none"> • 7.4 Satellite-based navigation
Planning with waypoints and tracks.	<ul style="list-style-type: none"> • 9.4 Waypoints overview • 9.5 Tracks •
Navigating using waypoints and tracks.	<ul style="list-style-type: none"> • 9.8 Navigation
Choosing electronic 2D cartography.	<ul style="list-style-type: none"> • 9.10 Chart selection • 9.2 Electronic charts overview <ul style="list-style-type: none"> – LightHouse charts – Navionics charts
Backing up and transferring Waypoints and Tracks.	<ul style="list-style-type: none"> • Saving user data and user settings
Displaying COG vectors	<ul style="list-style-type: none"> • 9.18 COG Vector
Viewing information for charted objects.	<ul style="list-style-type: none"> • 9.20 Chart objects
Controlling the level of information displayed on the Chart application	<ul style="list-style-type: none"> • 9.11 Chart Detail
Altering the Chart application's orientation to better suit your needs.	<ul style="list-style-type: none"> • 9.13 Chart orientation
Changing the boat symbol position in the Chart application.	<ul style="list-style-type: none"> • 9.15 Boat position
Changing the Depth at which the Deep Water contour changes color.	<ul style="list-style-type: none"> • 9.19 Deep Water

Note: To obtain full chart details, you must have a cartography chart card for the appropriate geographic area inserted into the card reader.

9.2 Electronic charts overview

Your multifunction display includes basic world base maps. Electronic charts provide additional cartographic information.

The level of cartographic detail available varies for different chart vendors, chart types, geographic locations and chart scales. The chart scale in use is indicated by the scale indicator, the value displayed is the distance that the line represents across the screen.

You can remove and insert chart cards at any time. The chart screen is automatically redrawn when the system detects that a compatible chart card has been inserted or removed.

Using a dual view page it is possible to display different cartography types simultaneously.

Caution: Care of chart and memory cards

To avoid irreparable damage to and / or loss of data from chart and memory cards:

- DO NOT save data or files to a card containing cartography as the charts may be overwritten.
- Ensure that chart and memory cards are fitted the correct way around. DO NOT try to force a card into position.
- DO NOT use a metallic instrument such as a screwdriver or pliers to insert or remove a chart or memory card.



LightHouse charts

With the introduction of the LightHouse II software, Raymarine multifunction displays now support the use of Raymarine's new LightHouse charts.

LightHouse charts are derived from vector and raster based charts, the LightHouse chart engine enables Raymarine to offer new chart types and regions from around the globe.



Refer to Raymarine's LightHouse Chart Store:
<https://charts.raymarine.com> for the latest information on available LightHouse charts.

Follow the link above and Go to the Getting Started page for full instructions on downloading LightHouse Charts to MicroSD card using the LightHouse Download Manager.

Raster charts

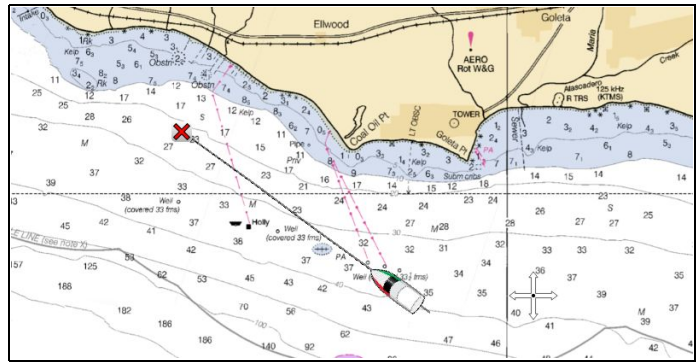

Raster charts are an exact copy / scan of an existing paper chart. All information is embedded directly in the chart. Ranging in and out of raster charts will make everything appear larger or smaller on the screen, including text. When changing the Chart application's orientation everything on the chart will rotate, including the text. As raster charts are a scanned image the file size is normally bigger when compared to the vector equivalent.

Vector charts

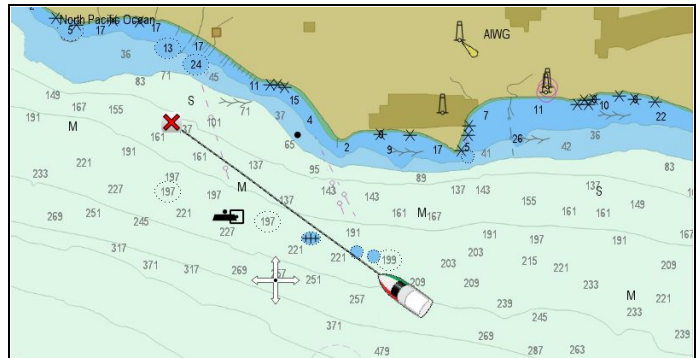

Vector charts are computer generated, consisting of a series of points and lines that make up the chart. Chart objects and overlays on vector charts can be switched on and off and chart objects can be selected to provide further information. Ranging in and out of vector charts will make geographical features appear larger or smaller on the screen, however text and chart objects will remain the same size regardless of range. When changing the Chart application's orientation geographical features will rotate but text and chart objects will remain in the correct orientation for the display. As vector charts are generated rather than a scanned image the file size is normally smaller when compared to the raster equivalent.

Unzipping files to memory card

The LightHouse charts download file must be unzipped / extracted to memory card for use on your multifunction display.

Note: The instructions below are provided for guidance only. Depending on your PC's operating system and the archiving (zip) software in use the steps required may differ slightly from those shown below. If you are unsure please consult your operating system's and or archiving software's help files.

To unzip / extract charts with a filesize over 4GB you may need to install 3rd-party archiving (zip) software such as 7zip: <http://www.7-zip.org/>.

Ensure you have a memory card with sufficient space for the charts you want to download. The File size is displayed on each chart region's download page.

For best performance it is recommended that you use Class 10 or UHS (Ultra High Speed) class memory cards.

1. Locate the downloaded file.

The file will be stored in the folder you selected or in your normal downloads folder.

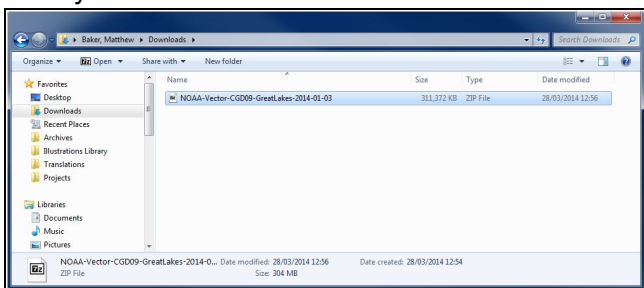

2. Right click on the file and select the **Extract Here** option from the zip options.

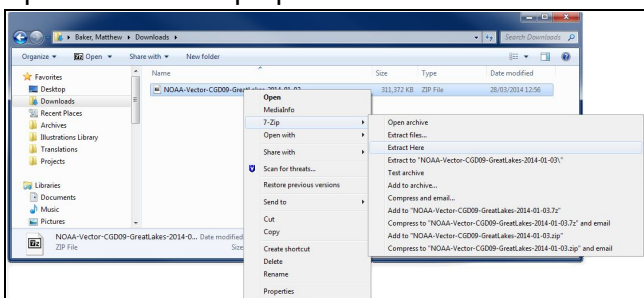

3. Once all files have been extracted select the chart files.

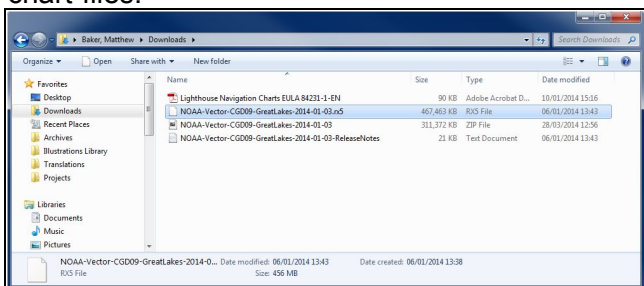

4. Right click and choose **Send to > Removable Disk**

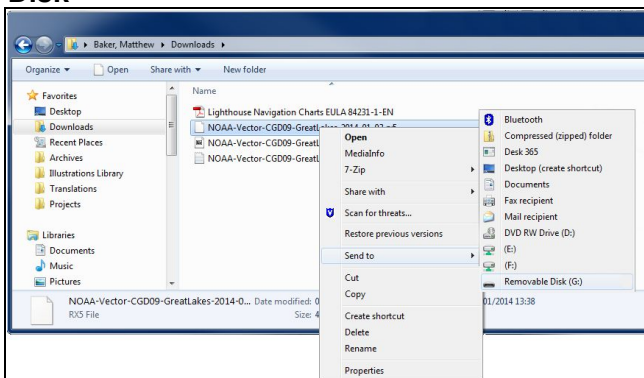

The Chart files will now be copied to your memory card.

5. Check that the files have been successfully placed on your memory card by viewing its contents in your file browser.

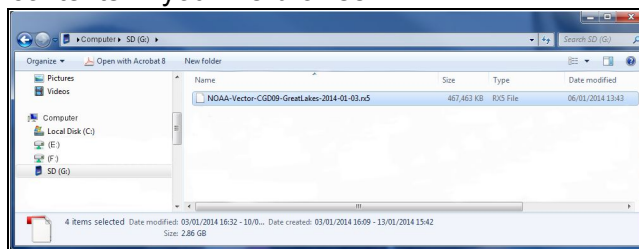

6. Safely remove your memory card from your PC's card reader.

7. Insert your memory card into the card reader of your multifunction display.

8. Open the Chart application on your multifunction display.

9. Select the new chart from the **Chart selection** menu: **Menu > Presentation > Chart Selection**.

The Chart screen will be redrawn to display the newly selected chart type.



Navionics charts

Your display is supplied with a base map and depending on unit a Navionics chart card. You may also purchase Navionics chart cards to get enhanced chart details and additional chart features.

Your display is compatible with the following Navionics chart cards:

- Silver
- Gold
- Gold+
- Hotmaps

Note: Refer to the Raymarine website (www.raymarine.com) for the latest list of supported chart cards.



C-MAP by Jeppesen charts

Your display is supplied with world base maps and depending on purchasing options a Jeppesen chart card. You may also purchase extra Jeppesen chart cards to get enhanced chart details and additional chart features.

Your display is compatible with the following Jeppesen chart cards:

- C-MAP Essentials
- C-MAP 4D MAX
- *C-MAP 4D MAX+

Refer to the Raymarine website (www.raymarine.com) for the latest list of supported chart cards.

To check the current availability of Jeppesen chart cards and types, please visit: www.jeppesen.com or c-map.jeppesen.com.

Note: *C-MAP 4D MAX+ cartography will work with **Dragonfly®** products however the '+' features will not be available.

9.3 Chart application controls

The Chart application consists of 2 modes: **Motion mode** and **Cursor mode**. The behavior of some controls are dependent upon mode. Options and settings can also be accessed from the Chart context menu.

Motion mode

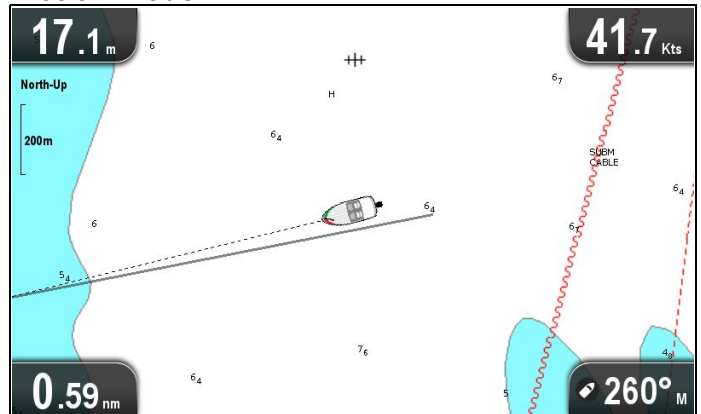

Motion mode is the default Chart application mode. In **Motion mode** the boat symbol remains centered onscreen and the Chart area moves around the boat symbol.

In **Motion mode** the controls behave as follows:

- pressing the **+** button ranges in.
- pressing the **-** button ranges out.
- pressing the **Ok** button opens the Chart application menu.
- pressing the **Back** button opens the **View switcher**.
- pressing any of the **Directional controls** enters **Cursor mode**.

Cursor mode

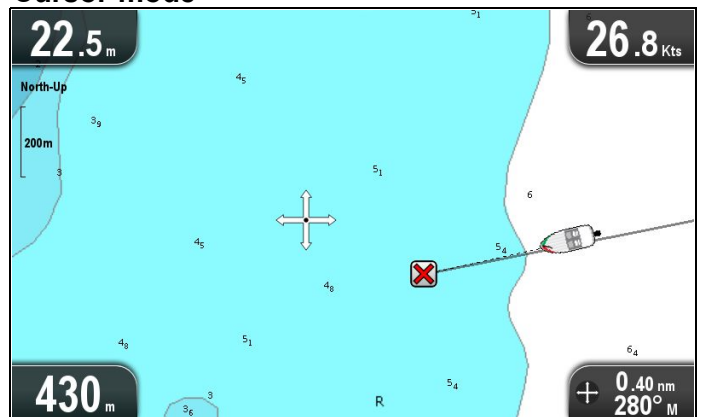

In **Cursor mode** the **Directional controls** are used to move around the Chart area. When the cursor reaches the edge of the screen the Chart area will pan in that direction.

In **Cursor mode** the controls behave as follows:

- using the **Directional controls** in any direction pans the chart area in that direction.
- pressing the **+** button ranges in.
- pressing the **-** button ranges out.
- pressing the **Ok** button opens the context menu.
- pressing the **Back** button returns the application to **Motion mode**.

Menus and dialogs

With a menu or dialog open the controls behave as follows:

- the **Directional controls** can be used to scroll through the menu's available options.
- pressing the **Ok** button selects the highlighted option, or confirms and dismisses pop up messages.
- pressing the **Back** button returns to the previous menu or closes the menu.

Chart context menu

Placing the cursor over an area in the chart application and pressing the OK button displays a context menu showing the cursor's positional data and menu items.

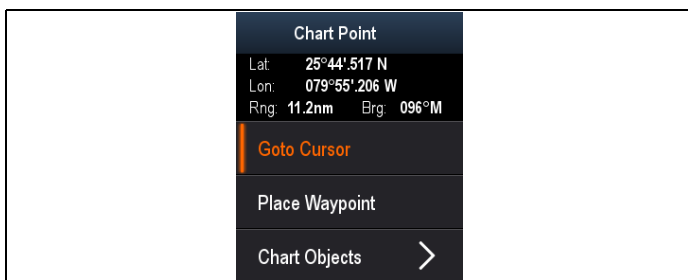

The context menu provides the following positional data for the cursor position in relation to your vessel:

- Latitude
- Longitude
- Range
- Bearing

The following menu items are available:

- **Goto Cursor / Stop Goto**
- **Place Waypoint**
- **Photo** (only available from a photo icon.)
- **Tide Station** (only available if a tide station is selected.)
- **Current Station** (only available if a current station is selected.)
- **Pilot Book** (only available at certain ports.)
- **Chart Objects**

9.4 Waypoints overview

Waypoints are position markers used for the purposes of navigation. Your display can create waypoints, which can then be selected for active navigation.

There are a range of features for placing, navigating and managing waypoints, these can be accessed from the Waypoints menu and Waypoint context menu. Waypoints are represented onscreen using customizable waypoint symbols. Waypoints can be created, moved, deleted. Waypoints can also be exported or imported.

Waypoint display examples

Waypoints in the chart application

In the chart application both active and inactive waypoints are shown. An active waypoint is the one that you are navigating to.

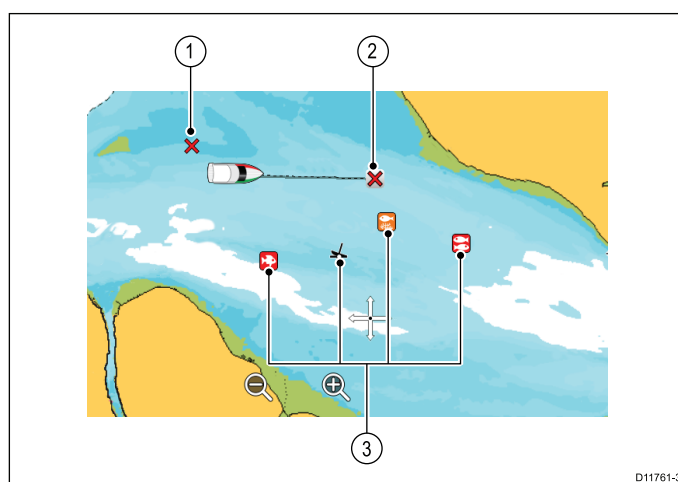

Item	Description
1	Inactive waypoint
2	Active waypoint
3	Alternative waypoint symbols

The default waypoint symbol is a red 'X'. Alternative symbols can be used if required.

Waypoints in the sonar and DownVision applications

Waypoints can be placed in the Sonar and DownVision applications.

Waypoints in the sonar and DownVision applications are represented by a vertical line labelled WPT.

Example 1 — Sonar application

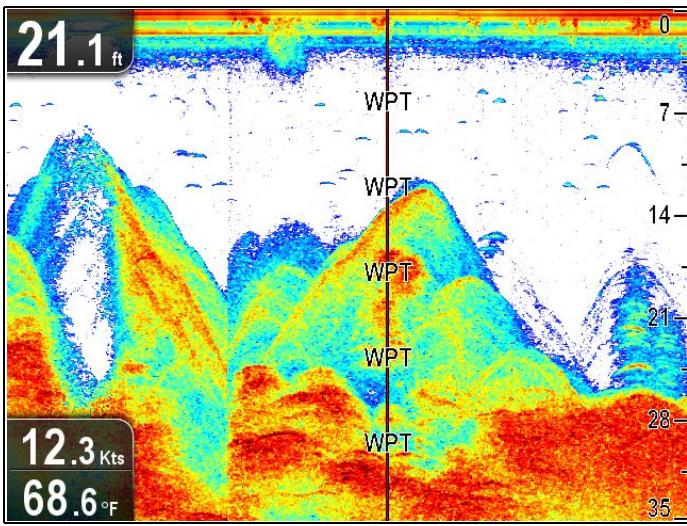

Example 2 — DownVision application

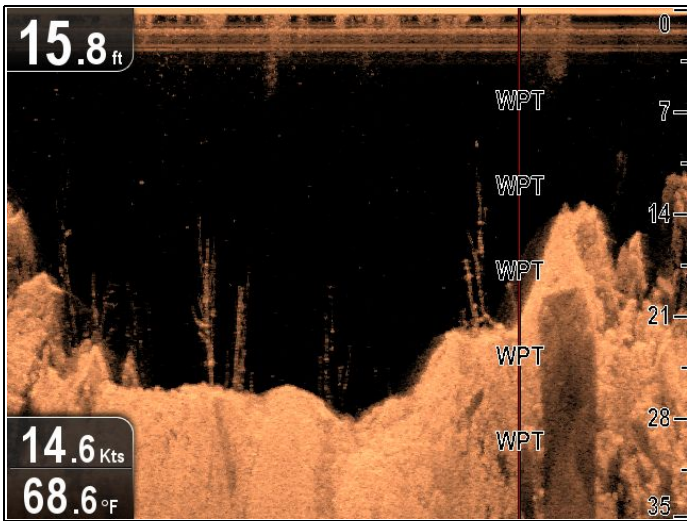

Waypoint context menu

The waypoint context menu shows the waypoint's positional data and related menu items.

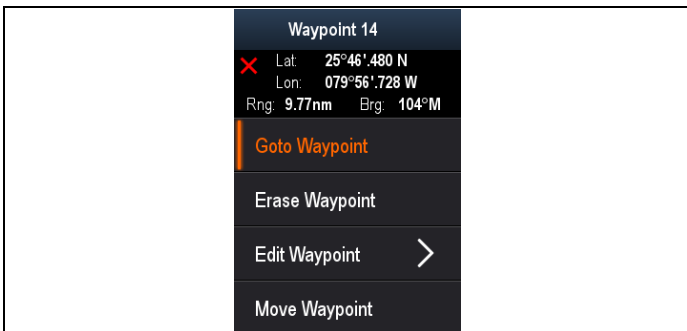

The context menu provides the following positional data for the waypoint in relation to your vessel:

- Latitude
- Longitude
- Range
- Bearing

The following menu items are available:

- **Goto Waypoint / Stop Goto**
- **Erase Waypoint**
- **Edit Waypoint**
- **Move Waypoint**

Accessing the context menu

You can access the context menu by following the steps below.

1. Use the **Directional controls** to highlight the waypoint.
The cursor changes to the WPT cursor.
2. Press the **OK** button.
The Waypoint context menu is displayed.

Waypoint placement

Placing a waypoint

Displays with a GPS / GNSS receiver can use waypoints to mark points of interest.

1. Use the **Directional controls** to highlight the desired location with the cursor.
2. Press the **OK** button.
The context menu is displayed.
3. Select **Place Waypoint**.
A confirmation pop up message is displayed.
4. Select **Ok** to place the waypoint, or **Edit** to edit the waypoint details.

A waypoint is placed at the cursor's location.

Placing a waypoint at your vessel's position

From the Chart application:

1. If required press the **Back** button to enter motion mode.
2. Press the **OK** button again to open the menu.
3. Select **Place Waypoint**.
A confirmation pop up message is displayed.
4. Select **Ok** to place the waypoint, or **Edit** to edit the waypoint details.

Waypoint groups

Waypoints are organized into groups. By default all waypoints are placed in the "UNSORTED" group.

New waypoint groups can be created and each waypoint can be assigned to a waypoint group. For example; you could create a waypoint group called "Fishing" and place all of your waypoints where you caught fish into that group.

Waypoint groups can be managed from the Waypoint groups list.



1. **All waypoints** — Displays a list of all waypoints saved on your system.
2. **Today's Waypoints** — Displays a list of all waypoints created or modified today.
3. **Unsorted** — By default new waypoints are added to the **UNSORTED** waypoint group. Selecting the group will display a list of all waypoints that have not been assigned to a specific group.
4. **Waypoint Groups** — All waypoint groups are displayed in the list.
5. **Search** — You can search for waypoints using keywords by selecting **Search**.
6. **New Group** — A new waypoint group can be added by selecting **New Group**.
7. **Import/Export** — Waypoints can be exported to or imported from a microSD card by selecting **Import/Export**. Refer to [Saving user data and user settings](#) for details.

Selecting a waypoints group from the list displays a list of all waypoints in that group. Additional functions are available to help manage your waypoints.

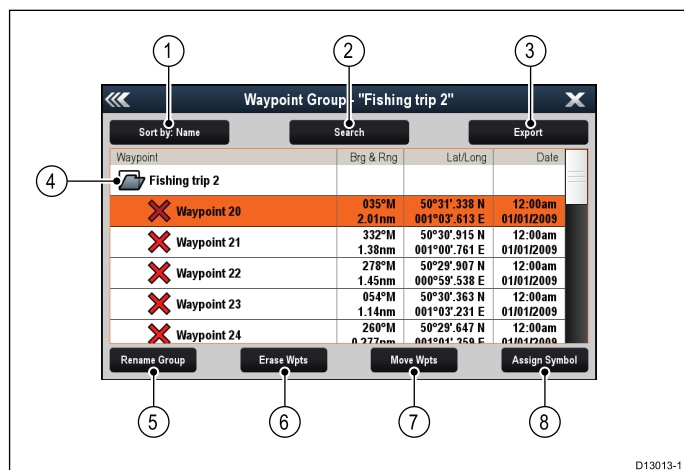

1. **Sort By:** — Sort waypoints by Name, Range, Symbol or Date.
2. **Search** — Search for waypoints using keywords.
3. **Export** — Exports the waypoint group currently displayed to a memory card.
4. **Waypoint group** — This is the currently selected waypoint group.
5. **Rename Group** — Rename the current group.
6. **Erase Wpts** — Erase all waypoints in the group.
7. **Move Wpts** — Move all waypoints in the group.
8. **Assign Symbol** — Assign a new symbol to all waypoints in the group.

Displaying the waypoints group list

From the Chart application:

1. If required, Press the **Back** button to enter motion mode.
2. Press the **Ok** button to open the Chart application menu.
3. Select **Waypoints**.
The waypoints group list is displayed.

Making a new waypoint group

With the Waypoint Group List displayed:

1. Select **New Group**.
The on-screen keyboard is displayed.
2. Use the on-screen keyboard to enter the required name for the new group.
3. select **SAVE**.

Renaming a waypoint group

With the Waypoint group list displayed:

1. Select the group you want to rename.
Group details are displayed.
2. Select **Rename Group**.
The on-screen keyboard is displayed.
3. Using the on-screen keyboard change the group name as required.
4. Select **SAVE**.

Assigning a new symbol to a waypoint group

You can assign a new waypoint symbol to all the waypoints in a group.

From the Waypoint group list:

1. Select the group that you want to assign a new waypoint symbol to.
A group details list is displayed showing all waypoints in the selected group.
2. Select **Assign Symbol**.
A list of all available symbols is displayed.
3. Select the symbol that you want to use for the waypoints in the selected group.
A confirmation dialog is displayed.
4. Select **Yes** to apply the new symbols to the waypoints, or select **No** to **cancel**.

Moving a waypoint to a different group

With the Waypoints group list displayed:

1. Select **ALL WAYPOINTS**.
A list of all waypoints currently on your system is displayed.
2. Select the waypoint you want to move.
The waypoint details page is displayed.
3. Select the **Group** field
A list of all groups is displayed.
4. Select the **Group** that you want to move the waypoint to, or
5. Select **Create New Group** to move the waypoint to a new group.

The waypoint is moved to the selected group.

Moving all waypoints in a group to a different group

You can move all waypoints in a group to a different group.

With the Waypoints group list displayed:

1. Select the Group that contains the waypoints you want to move.

2. Select **Move Wpts.**

A list of all groups is displayed.

3. Select the group from the list that you want to move the waypoints too.

A confirmation dialog is displayed.

4. Select **Yes** to move the waypoints or **No** to cancel.

The waypoints have now been moved to the new group.

Erasing all waypoints in a group

You can erase all waypoints in a selected group.

With the waypoint groups list displayed:

1. Select the group that contain the waypoints you want to erase.

A list is displayed showing all waypoints in the selected group.

2. Select **Erase Wpts.**

A confirmation dialog is displayed.

3. Select **Yes** to erase all waypoints in the group, or **No** to cancel.

All of the waypoints in the selected group are erased from the system and the group will now be empty.

Erasing a waypoint group

Before you can erase a waypoint group you must move or erase all the waypoints assigned to that group.

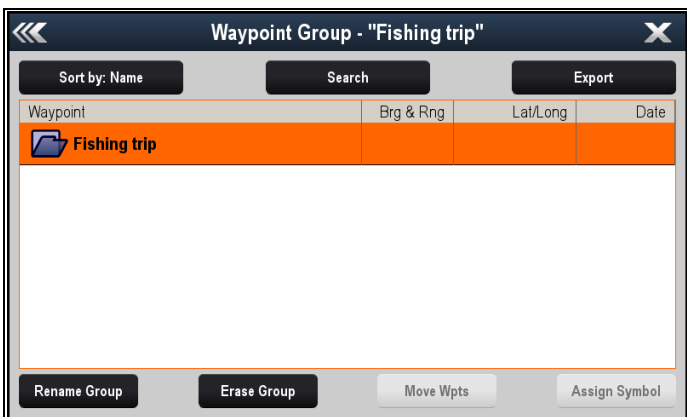

With the Waypoint Group displayed:

1. Select the waypoint group that you want to erase.
2. Select **Erase Group.**

The group is deleted from the system.

Waypoint information

When you create a waypoint, the system assigns information regarding the location marked. You can view and edit the details of any waypoint that has been created and stored.

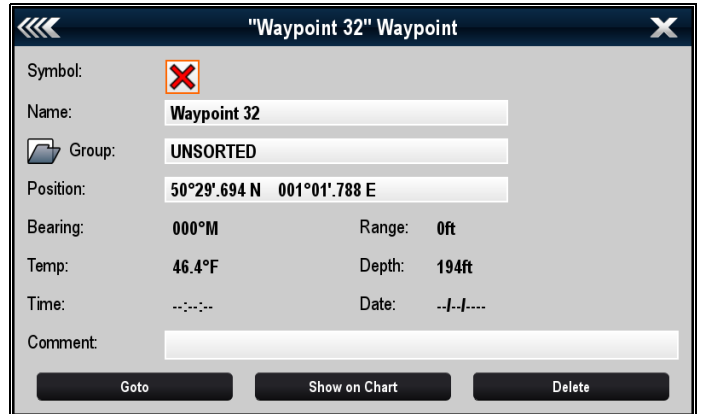

The following information is assigned or captured for each waypoint:

- **Symbol** (a default symbol is assigned, or you can select an alternative.)
- **Name** (a default name is assigned, or you can select an alternative.)
- **Position** (Latitude and Longitude of the waypoint.)
- **Bearing** and **Range** (Bearing and range from vessel.)
- **Temperature** (requires appropriate sensor, only for waypoints captured at the vessel position.)
- **Depth** (requires appropriate sensor, only for waypoints captured at the vessel position.)
- **Date and time**
- **Comment** (you can add your own text comments to a waypoint.)

From the waypoint information page you can also perform the following actions:

- **Goto** (Start active navigation to the waypoint.)
- **Show on Chart** (Show the waypoint location in the chart application.)
- **Delete** (Delete the waypoint from the waypoints list.)

Editing waypoint details

With the Waypoint List displayed:

1. Select the waypoint you want to edit.
The waypoint information page is displayed.
2. Select the field you want to edit.
3. Use the on-screen keyboard to make the changes, then select the on-screen keyboard's **SAVE** button.

Editing a waypoint using the context menu

With the application page displayed:

1. Select the waypoint symbol on-screen.
The waypoint context menu is displayed.
2. Select **Edit Waypoint.**
The edit waypoint dialog is displayed.
3. Select the field you want to edit.

- Use the on-screen keyboard to make the changes, and then select the on-screen keyboard's **SAVE** key.

Moving waypoints

Moving a waypoint using the context menu

With the application page displayed:

- Select the waypoint symbol on-screen.
The waypoint context menu is displayed.
- Select **Move Waypoint**.
- Select the new position for the waypoint.

Moving a waypoint by entering new coordinates

With the Waypoint List displayed:

- Select **All Waypoints**.
- Select the relevant waypoint.
The waypoint information page is displayed.
- Select the Position field.
- Use the on-screen keyboard to make the changes, and then select the on-screen keyboard's **SAVE** key.

Erasing waypoints

Erasing a waypoint using the context menu

With the application page displayed:

- Select the waypoint symbol on-screen.
The waypoint context menu is displayed.
- Select **Erase Waypoint**.
The erase waypoint pop up message is displayed.
- Select **Yes** to confirm, or **No** to cancel.

Erasing a waypoint using the waypoint list

With the Waypoint List displayed:

- Select **All Waypoints**.
- Select the waypoint you want to erase.
The waypoint information page is displayed.
- Select **Erase**.
The erase waypoint pop up message is displayed.
- Select **Yes** to confirm, or **No** to cancel.

Erasing all waypoints from the system

Note: The following procedure permanently deletes all Waypoints from the display. BEFORE proceeding, ensure that you backup any data that you want to keep on to a MicroSD card.

From the **Backup & Reset** menu:

- Select **Erase from System**.
- Select **Erase Waypoints from System**.
A confirmation dialog is displayed.
- Select **Yes** to confirm.

Accessing the backup & reset menu

Depending on display variant, the **Backup & Reset** menu can be accessed by:

- selecting **Backup & Reset** from the **Tools & Settings** page (**Pro** variants), or by
- selecting: **Menu > System settings > Backup & Reset** from the application menu (**5 M**).

Waypoint search

The waypoint search feature allows you to search for waypoints on your system.

The search feature is available by selecting **Search** from the Waypoints list.

Waypoints can be searched for by:

- Name or keyword
- Symbol
- Area

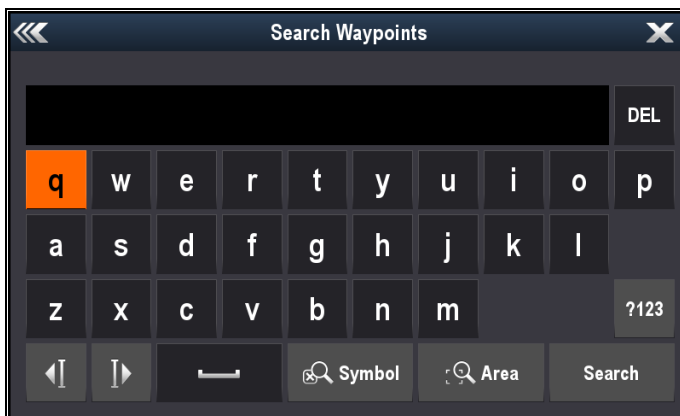

From the search results you can erase all the waypoints in the search list, move them to an existing or new waypoint group or assign all of the waypoints the same waypoint symbol.

Searching for waypoints by name or keyword

Waypoints can be searched for by name or keyword.

From the Waypoints list:

- Select **Search**.
The search page is displayed.
- Use the on-screen keyboard to enter the waypoint name or keyword.
- Select **Search**.
The search results are displayed.

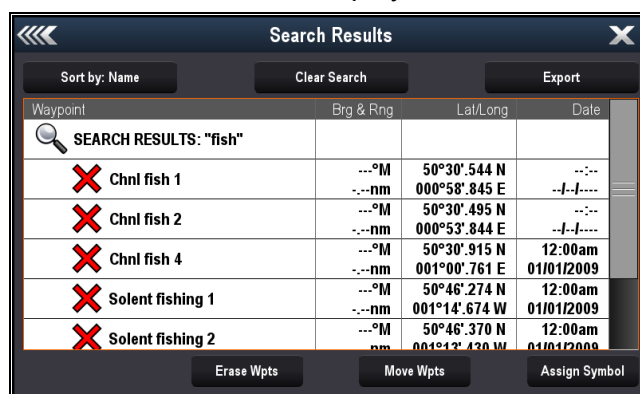

- Select **Erase Wpts** to erase the list of waypoints from your system, or
- Select **Move Wpts** to move the waypoints to a new or existing group, or
- Select **Assign Symbol** to assign a new symbol to all the waypoints in the search results list.

You can also select a waypoint from the list to view its details, or if accessed from the Chart application set a goto or display the waypoint in the Chart application.

Searching for waypoints by symbol

Waypoints can be searched for by waypoint symbol.

From the Waypoints list:

1. Select **Search**.
The search page is displayed.
2. Select **Symbol**.
The waypoints symbol list is displayed.
3. Select the symbol that is assigned to the waypoint(s) you want to search for.
A list of all waypoints using the selected symbol is displayed.

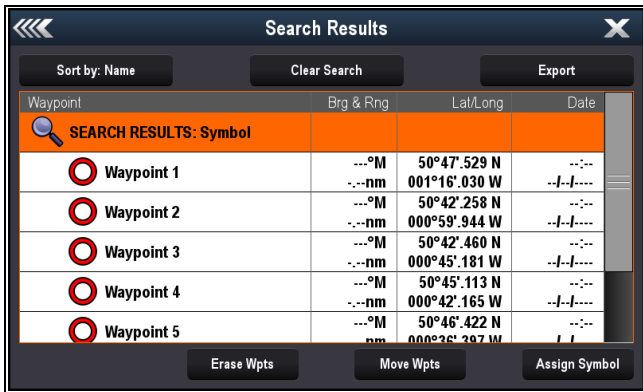

4. Select **Erase Wpts** to erase the list of waypoints from your system, or
5. Select **Move Wpts** to move the waypoints to a new or existing group, or
6. Select **Assign Symbol** to assign a new symbol to all the waypoints in the search results list.

You can also select a waypoint from the list to view its details, or if accessed from the Chart application set a goto or display the waypoint in the Chart application.

Searching for waypoints by area

Waypoints can be searched for by selecting an area in the Chart application.

From the Chart application menu:

1. Select **Waypoints**.
The waypoints list is displayed.
2. Select **Search**.
The search page is displayed.
3. Select **Area**.
The Chart application is displayed with the area search menu open.
4. Select the location for the first corner point of the search area.
5. Select the location for the opposite corner of the search area.
A box is drawn on the screen which covers the selected area.

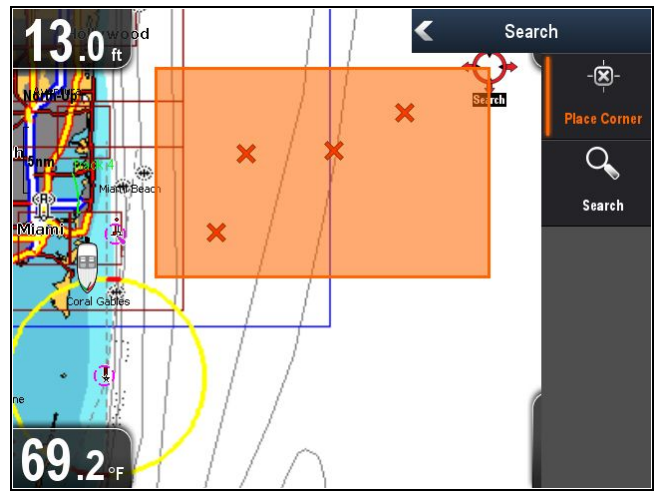

- If the box is drawn in the wrong place you can draw a new area by selecting 2 new corner points.
6. Select **Search** from the menu.
A list of all waypoints in the selected area is displayed.

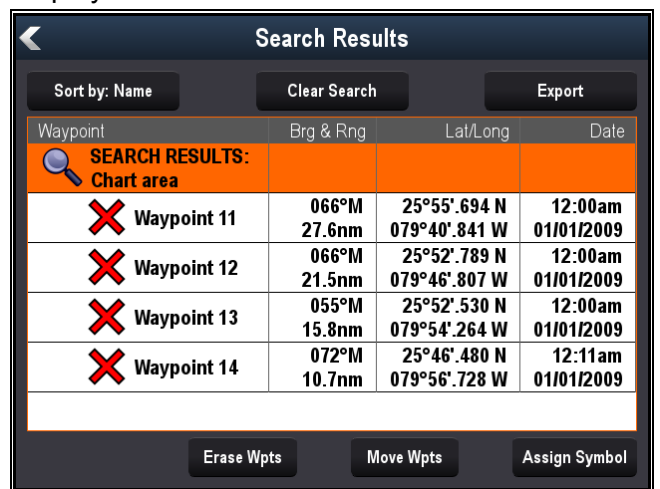



































7. Select **Erase Wpts** to erase the list of waypoints from your system, or
8. Select **Move Wpts** to move the waypoints to a new or existing group, or
9. Select **Assign Symbol** to assign a new symbol to all the waypoints in the search results list.



































You can also select a waypoint from the list to view its details, set a goto or display the waypoint in the Chart application.











Waypoint symbols

A Range of waypoint symbols are available that can be used to represent different waypoint types.

	Black Cross		Red Cross
	Black Circle		Red Circle
	Black Square		Red Square
	Black Triangle		Red Triangle

	Blue Cross		Green Cross
	Blue Circle		Green Circle
	Blue Square		Green Square
	Blue Triangle		Green Triangle
	Anchor		Wreck
	Buoy		Fuel
	Toilets		Restaurant
	Ramp		Caution
	Green racemark anti-clockwise		Green Racemark clockwise
	Yellow racemark anti-clockwise		Yellow Racemark clockwise
	Red racemark anti-clockwise		Red Racemark clockwise
	Marker		Restriction
	Bottom Mark		Top Mark
	Route Start		Route End
	Diver Down		Diver Down 2
	Oil Rig		Filled Circle
	FAD (Fish Attracting Device)		Concrete Rubble

	Seaweed		Oyster
	Green Can		Green Nun
	Red Can		Red Nun
	Yellow Can		Yellow Nun
	Fish Trap		Brushpile
	Preferred Marks		Post
	Ledge		Fish
	Fish 1 Star		Fish 2 Star
	Fish 3 Star		School Fish
	Lobster		Small Fish
	Rocks		Reef
	Private Reef		Public Reef
	Dolphin		Shark
	Billfish		Tank
	Reef Ball		Sailboat
	Sportsfisher		Trawler
	Swimmer		Martini

	Tree		Tower
	Hill or Peak		Bridge
	Airplane		Car
	Skull		Diamond T
	Diamond Quarter		Filled Triangle

9.5 Tracks

A track is an on-screen trail that shows the passage you have taken. This trail is made up of a series of track points which are created automatically. You can save the track to create a permanent record of where you have been.

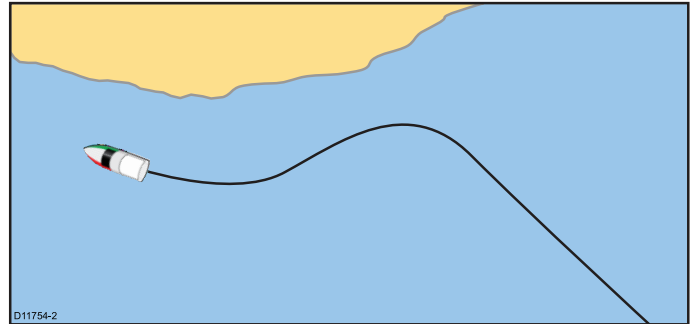

Creating a track

From the chart application menu:

1. Select **Navigate**.
2. Select **Start Track**.
The start track pop up message is displayed.
3. Select **Ok**.
As you navigate your vessel, your journey is automatically recorded as a track.

Note: If the power fails whilst a track is being recorded or the position fix is lost, a break will occur in the track.

Note: If the maximum number of tracking points is reached, you will be warned. The track will continue to be recorded with the earlier tracking points being overwritten.

4. To complete your track select **Stop Track** from the **Navigate** menu: **Menu > Navigate > Stop Track**.
The track stopped pop up message is displayed.
5. Select **Save**, **Erase** or **Cancel**.
 - **Save** — Will save the track and open the Edit track Properties dialog where you can name the track and choose a color for the track line.
 - **Erase** — Will erase the track.
 - **Cancel** — Will cancel the Stop Track action.

Track context menu

The Track context menu shows the track length, number of points and menu items.

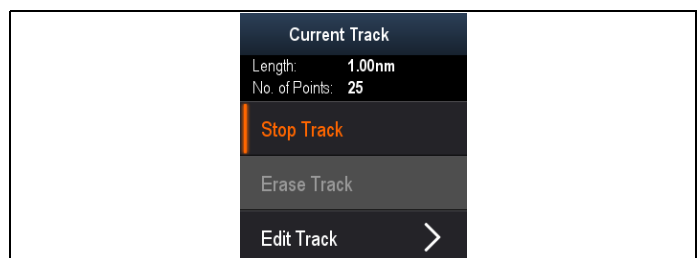

The context menu provides the following menu items:

- **Stop Track** (only available during track creation.)
- **Stop Goto** (only available during active navigation.)

- **Erase Track** (not available during track creation.)
- **Edit Track**

Accessing the context menu

You can access the context menu by following the steps below.

1. Use the **Directional controls** to highlight the Track.
The cursor changes to the Track cursor.
2. Press the **OK** button.
The Track context menu is displayed.

Track editing

You can edit aspects of the stored tracks.

You can:

- Erase a track.
- Change the name of a track.
- Change the color of a track.

Displaying the track list

To display the track list follow the steps below.

From the Chart application menu:

1. Select **Tracks**.
The track list is displayed.

Renaming a track

You can change the name of a saved track.

With the track list displayed.

1. Select the track you want to edit.
The track options page is displayed.
2. Select **Edit Name**.
The on-screen keyboard is displayed.
3. Use the on-screen keyboard to change the track name.
4. When finished Select **SAVE**.

You can also edit track details by selecting **Edit Track** from the track context menu.

Changing the color of a track

You can change the color of a saved track.

With the track list displayed.

1. Select the track you want to edit.
The track options page is displayed.
2. Select **Edit Color**.
A list of colors is displayed.
3. Select the color you want to use.

You can also edit track details by selecting **Edit Track** from the track context menu.

Erasing tracks

Erasing a track

You can erase tracks from the system.

From the Chart application:

1. Select the **Track** on-screen
The track context menu is displayed.
2. Select **Erase Track**.
A confirmation pop-up dialog is displayed.
3. Select **Yes** to erase the track, or
4. Select **No** to keep the track.

You can also erase a track by selecting the relevant track from the Track list and selecting **Erase Track**.

9.6 Import and Export

Waypoints and Tracks can be imported and exported using a MicroSD card.

Saving waypoints and tracks to a memory card

Chartplotter variant displays can save their waypoints and tracks to MicroSD card.

Ensure a blank card (NOT a cartography card) is inserted into the card reader.

From the Chart application:

1. If required press the **Back** button to enter Motion mode.
2. Press the **OK** button to display the menu.
3. Select **Waypoints** or **Tracks** as required.
The Waypoints or Track list is displayed.
4. Select **Import/Export**.
5. Select **Save Waypoints to Card** or **Save Tracks to Card** as required.
6. Select the Waypoints or Tracks that you want to save, or select **Select All**.
7. Select **Save**.
The onscreen keyboard is displayed.
8. Enter a Filename.
The default filenames are **Waypoints** and **Tracks**.
9. Select **Save**.
A confirmation dialog is displayed.
10. Select **OK** to acknowledge and return to normal operation, or
11. Select **Eject device** if you want to remove the MicroSD card from the card reader.

Importing waypoints or tracks from a memory card

Chartplotter variant displays can import waypoints and tracks from MicroSD card.

Ensure that the MicroSD card that contains your saved waypoints and / or tracks is inserted into the card reader.

From the Chart application:

1. If required press the **Back** button to enter Motion mode.
2. Press the **OK** button to display the menu.
3. Select **Waypoints** or **Tracks** as required.
The Waypoints or Track list is displayed.
4. Select **Import/Export**.
5. Select **Retrieve from Card**.
The file browser is displayed.
6. Navigate to the gpx file you want to import.
7. Select the file.
A confirmation dialog is displayed.
8. If there is a naming conflict between waypoints or tracks already on your system and the waypoints or tracks you are trying to import you will be prompted to either:

- i. **Copy as new Waypoint** — The waypoint or track will be imported and be assigned the next default name.
- ii. **Copy & Replace** — The waypoint or track on your system will be overwritten with the imported waypoint or track with the same name .
- iii. **Don't Copy** — The waypoint or track with the naming conflict will not be imported.

When completed a Retrieving complete dialog box is displayed.

9. Select **OK**.

9.7 Waypoints and tracks storage capacity

The display can store the following quantities of waypoints and tracks.

Waypoints	3,000 waypoints (split between up to 100 waypoint groups)
Tracks	15 tracks (each track can contain up to 10,000 points)

9.8 Navigation

Navigating to the cursor's location

In Cursor mode you can set the Chart application to guide you to the cursor's location.

1. Use the **Directional controls** to move the cursor to the desired location.
2. Press the **OK** button.
The context menu is displayed.
3. Select **Goto Cursor**.

Navigating to a waypoint

You can set the Chart application to guide you to a waypoint.

1. Use the **Directional controls** to highlight a waypoint.
2. Press the **OK** button.
The context menu is displayed.
3. Select **Goto Waypoint**.

Navigating to a waypoint from the waypoints list

From the Chart application:

1. If required, press the **Back** button to enter motion mode.
2. Press the **OK** button to open the menu.
3. Select **Waypoints**.
The Waypoints list is displayed.
4. Select the waypoint you want to navigate to.
The Waypoint information page is displayed.
5. Select **Goto**.

Cancelling navigation to a waypoint

1. Select any position anywhere on-screen.
The waypoint context menu is displayed.
2. Select **Stop Goto**.
3. Alternatively, in the chart application, go to: **Menu > Navigate > Stop Goto**.

Note: Once navigation is no longer active, the waypoint symbol returns to its normal state, and the dashed line between your vessel and the waypoint is removed.

Arriving at a waypoint

As your vessel approaches the target waypoint, the waypoint arrival alarm provides a warning.

1. Select **Ok** on the waypoint arrival alarm pop up message.

Note: You can set the approach distance (radius) at which the waypoint arrival alarm will sound using the **Waypoint Arrival** alarm located in the **Alarms** menu

Accessing the alarms menu

Depending on display variant, the **Alarms** menu can be accessed by:

- selecting **Tools & Settings** from the View Switcher (**Dragonfly-4 Pro**, **Dragonfly-5 Pro**, and **Dragonfly-7**), or by
- selecting **System Settings** from the application menu (**Dragonfly-4 DV**, **Dragonfly-4 DVS**, **Dragonfly-5 DVS** and **Dragonfly-5 M**).

9.9 Chart settings menu — cartography compatibility

The options available in the Chart settings menu are dependent on the cartography in use. If the cartography in use is not compatible then the menu option will not be shown.

Menu option	Compatible cartography
Chart Selection	<ul style="list-style-type: none"> • LightHouse Charts • Navionics® Charts • Jeppesen®
Chart Detail	<ul style="list-style-type: none"> • LightHouse Charts • Navionics® Charts • Jeppesen®
High Res Bathy	<ul style="list-style-type: none"> • Jeppesen®
Chart Orientation	<ul style="list-style-type: none"> • LightHouse Charts • Navionics® Charts • Jeppesen®
Text/Symbol Size	<ul style="list-style-type: none"> • Jeppesen®
Boat Position	<ul style="list-style-type: none"> • Navionics® Charts
Community Edits	<ul style="list-style-type: none"> • LightHouse Charts • Navionics® Charts • Jeppesen®
Sonar Logs	<ul style="list-style-type: none"> • Navionics® Charts
COG Vector	<ul style="list-style-type: none"> • LightHouse Charts • Navionics® Charts • Jeppesen®
Deep Water From	<ul style="list-style-type: none"> • LightHouse Charts • Navionics® Charts • Jeppesen®

9.10 Chart selection

You can select the cartography type to be used in the Chart application. The Chart selection applies to the active Chart instance. You must have the necessary cartography chart cards inserted into your multifunction display in order to display different cartography type.

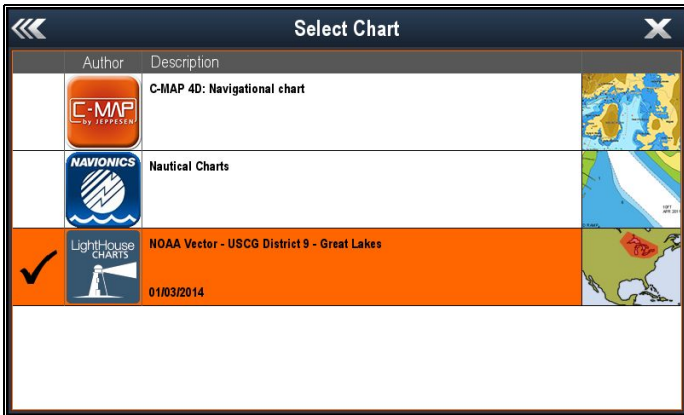

Selecting the Cartography type

You can select the cartography type you want to display in the Chart application.

Ensure you have inserted the chart card that contains the cartography type you want to display.

From the Chart application menu:

1. Select **Chart Settings**.
2. Select **Chart Selection**.
A list of available cartography is displayed.
3. Select the cartography type you want to display
The Chart window is re-drawn to show the select cartography type.

9.11 Chart Detail

The chart detail setting determines the amount of detail shown in the Chart application.

Selecting the Low option for the **Chart Detail** disables the following objects:

- Community Layer
- Chart Text
- Chart Boundaries
- Light Sectors
- Routing Systems
- Caution Areas
- Marine Features
- Land Features
- Panoramic Photo
- Roads
- Additional Wrecks
- Color Seabed Areas
- Depth Contours

Changing the level of chart detail

You can change the level of detail, displayed in the Chart application.

In Motion mode:

1. Press the **OK** button.
The Chart application menu is displayed.
2. Select **Chart Settings**.
3. Select **Chart Detail**.
Selecting Chart Detail switched the detail between High and Low.

9.12 High resolution bathymetry

The **High Res Bathy** setting is available when using Jeppesen charts and switches the display to view high resolution bathymetry data.

Note: With **High Res Bathy** switched on the cartography is not suitable for navigation.

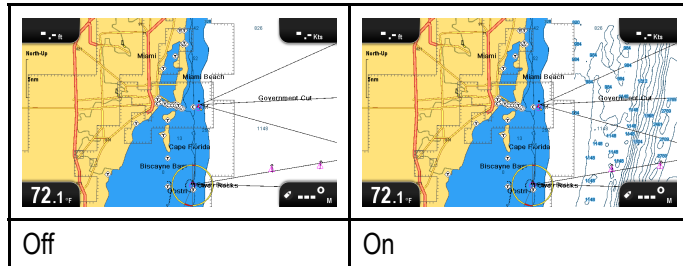

Switching High Res Bathy on and off

If supported by your cartography type, the chart can be switched to display high resolution bathymetry data.

From the Chart application menu:

1. Select **Chart Settings**.
2. Select **High Res Bathy**: so that On is selected to display high resolution bathymetry data, or
3. Select **High Res Bathy**: so that Off is selected to turn off high resolution bathymetry data.

9.13 Chart orientation

The orientation of a chart refers to the relationship between the chart and the direction that you are travelling in.

The mode you choose applies to all chart views, and is restored at power up.

The following options are available:

North Up

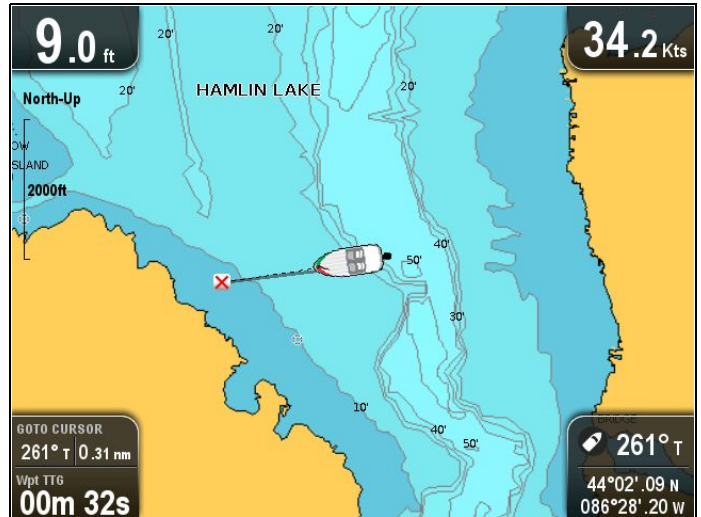

In **North Up** mode, the **Chart Orientation** is fixed with true north pointing up (this is the usual orientation for nautical charts). As your heading changes the vessel symbol rotates accordingly. This is the default orientation for the Chart application.

Course Up

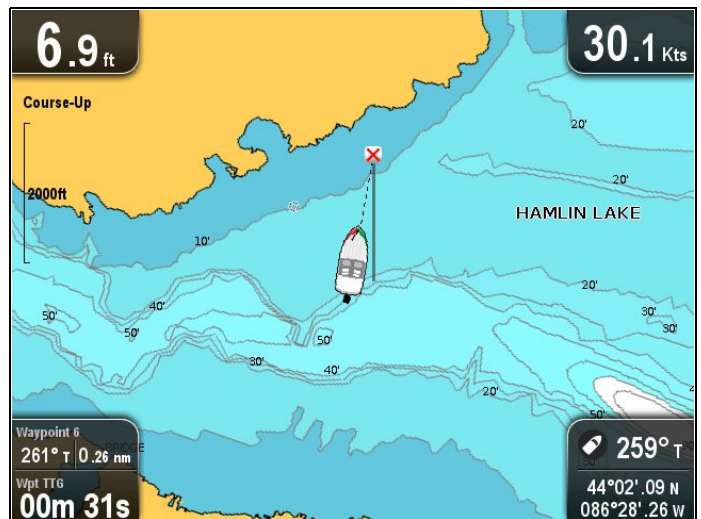

In **Course Up** mode, during active navigation, the Chart application displays the vessel's current destination waypoint directly up. As your COG changes, the boat symbol moves accordingly. If you select a new course, the picture will reset to display the new course upwards.

If COG data becomes unavailable **Course Up** mode is suspended and the Chart application will set COG to 0°.

Setting the chart orientation

From the chart application menu:

1. Select **Chart settings**.

2. Select **Chart Orientation**.

Selecting Chart Orientation switches between North Up and Course Up.

9.14 Text and Symbol size

The size that text and symbols appears when using Jeppesen cartography can be adjusted to make the screen easier to read from **Normal** to **Large**

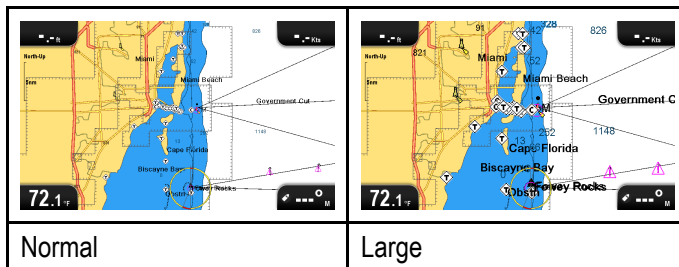

Switching text and symbol size

If supported by your cartography type, the display text and symbols size can be increased.

From the Chart application menu:

1. Select **Chart Setting**.
2. Select **Text/Symbol Size**: so that Large is selected to increase the size of text and symbols in the Chart application, or
3. Select **Text/Symbol Size**: so that Normal is selected to reduce text and symbol size to normal.

9.15 Boat position

The **Boat position** function determines the position of the boat symbol on-screen.

Center

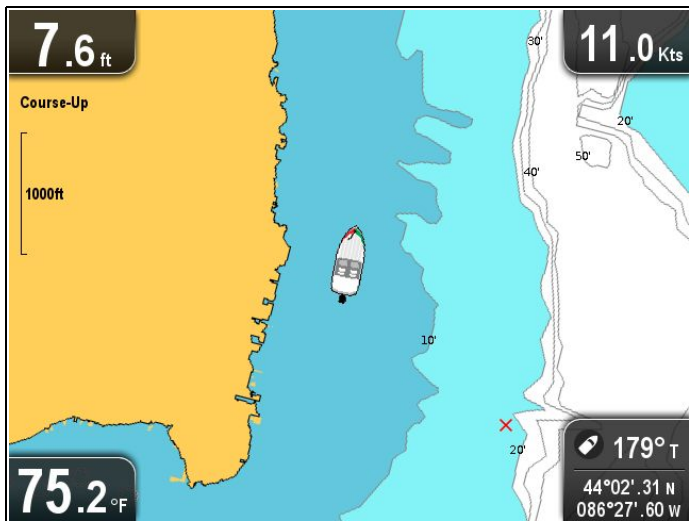

With **Boat position** set to Center the boat symbol remains in the center of the screen.

Offset

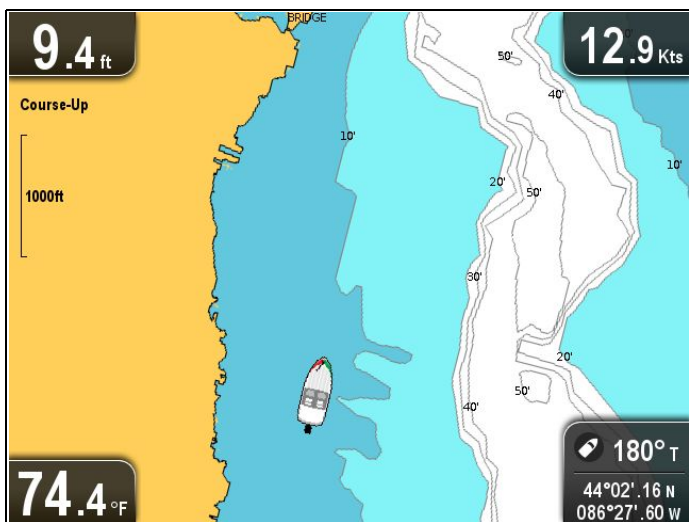

With **Boat position** set to Offset the boat symbol is offset from the center of the screen so that more Chart area is visible in front of the boat symbol.

Changing the boat position

You can change the position the vessel icon is displayed on-screen.

From the Chart application menu:

1. Select **Chart Settings**.
2. Select **Boat Position**.

Selecting Boat Position switches the boat position between Center and Offset.

9.16 Community layer

If supported by your cartography type, you can display User Generated Content (UGC) on the Chart application.

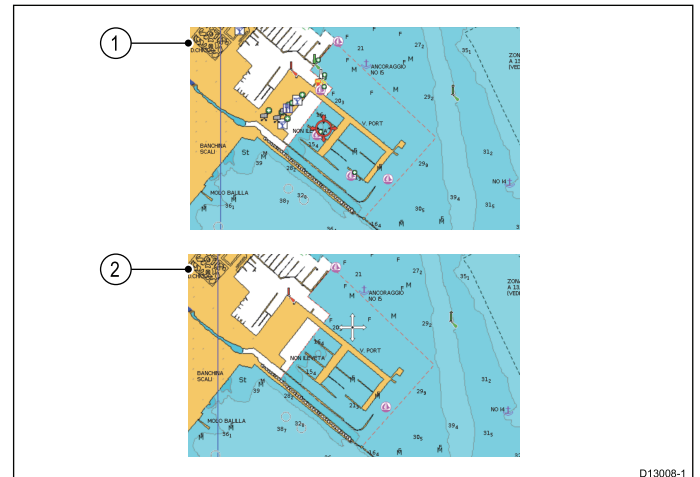

1. Community feature On.
2. Community feature Off.

To check if your Navionics cartography supports community edits downloads please refer the Navionics website: for information and instructions on downloading the updates to your chart card.

Switching the community layer on and off

If supported by your cartography type, the User Generated Content (UGC) overlay can be switched on and off by following the steps below.

From the Chart application menu:

1. Select **Chart Setting**.
2. Select **Community Edits**: so that On is selected to display UGC, or
3. Select **Community Edits**: so that Off is selected to turn off UGC.

9.17 Sonar logging

When using compatible **Navionics**® cartography you can share sonar information using **Navionics**® **SonarCharts**™.

The **Sonar Logging** function allows logging of depth and position data to a compatible **Navionics**® chart card. The saved data can then be uploaded to the **Navionics**® website to help improve the contour detail of Sonar Charts on your **MFD**. Refer to the **Navionics**® website for instructions on how to upload your sonar logs.

Enabling and disabling Sonar logs

Sonar logging can be enabled or disabled at any time.

From the Chart application menu:

1. Select **Chart Setting**.
2. Select **Sonar Logs**: so that On is selected to enable sonar logging, or
3. Select **Sonar Logs**: so that Off is selected to disable sonar logging.

9.18 COG Vector

The chart application can be set to display a green line to represent Course Over Ground (COG).

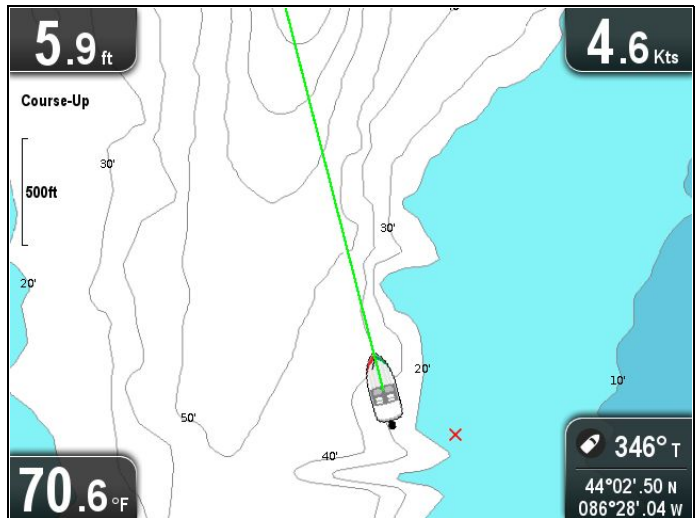

The green line indicates the vessel's actual course.

Enabling and disabling the COG vector

You can enable and disable the COG vector.

From the Chart application menu:

1. Select **Chart Settings**.
2. Select **COG Vector** to switch between On and Off.

9.19 Deep Water

Water depth can be represented using blue shading with white used to represent deep water.

The depth at which water color turns from blue shading to white can be changed to suit user requirements.

Example 1 — Deep water from: 60 ft

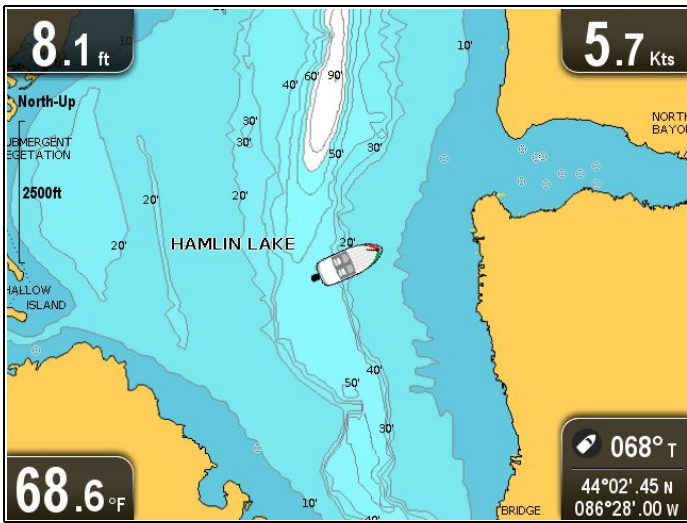

Example 2 — Deep water from: 6 ft

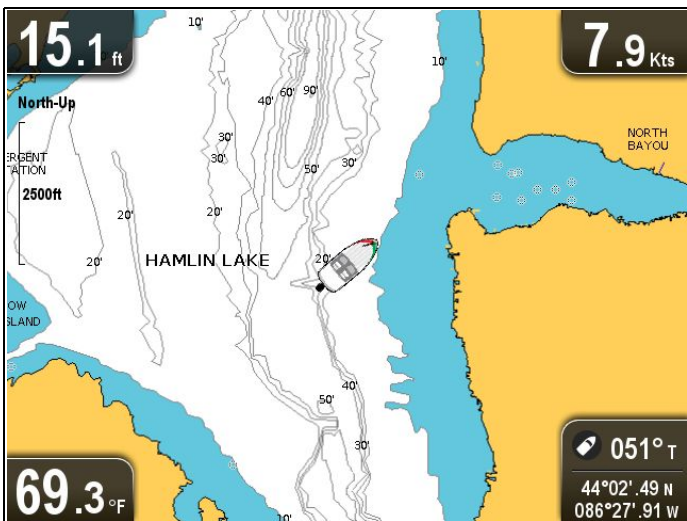

The deep water feature can also be turned off so that all water appears as white.

Note: The Deep Water function is restricted to the depth data available on your chart card.

Changing the Deep Water From setting

You can choose the depth that water changes color to white.

From the Chart application menu:

1. Select **Chart Settings**.
2. Select **Deep Water From:**.
3. Select the relevant depth, or select Off.

Selecting Off will display all water as white regardless of depth.

9.20 Chart objects

If supported by your cartography type, you can display additional information in the chart application for cartographic objects, ports, or marinas.

Depending on the chart card you are using, you can view some or all of the following additional information:

- Details of each cartographic object that is marked on the chart, including source data for structures, lines, open sea areas, and so on.
- Details of ports, port features, and business services.
- Pilot book information (similar to what you would see in a marine almanac). Pilot book information is available at certain ports.
- Panoramic photos of ports and marinas. The availability of photos is indicated by a camera symbol on the chart display.

This information can be accessed using the chart context menu options.

Note: The amount of object information available depends upon the electronic charts that you are using for your system. For full details of the features available for your chart cards contact your chart card supplier.

Displaying pilot book information

From the chart application, when a port symbol is displayed for a port which has a pilot book:

1. Select the port symbol.
The chart context menu will be displayed.
2. Select **Pilot Book**.
3. Select the relevant chapter.

Displaying panoramic photos

From the chart application, when a camera symbol is displayed, indicating the availability of a photo:

1. Select the camera symbol.
The chart context menu is displayed.
2. Select **Photo**.
The photo is displayed on screen.

Note: Not all cartography types are capable of displaying panoramic photos.

Displaying chart object information

From the chart application:

1. Select an object.
The chart context menu is displayed.
2. Select **Chart Objects**.
The Chart Object Dialog is displayed.
3. Selecting available options will display detailed information about that item.
4. Selecting the position in the dialog will close the information dialog and position the cursor over the object.

9.21 5 M System settings menu

The **System Settings** menu on the **5 M** variant display is located in the main application menu.

Refer to [11.1 System Settings menu](#) for details on available options for your display variant.

Chapter 10: Mobile applications

Chapter contents

- 10.1 **Wi-Fish™** mobile app on page 94
- 10.2 Connecting Wi-Fi — Pro displays on page 94

10.1 Wi-Fish™ mobile app

Raymarine's **Wi-Fish™** mobile app is available on iOS 7 or greater and Android 4 or greater which enables control of the **Pro** variant displays using a smart device such as a tablet or smartphone.

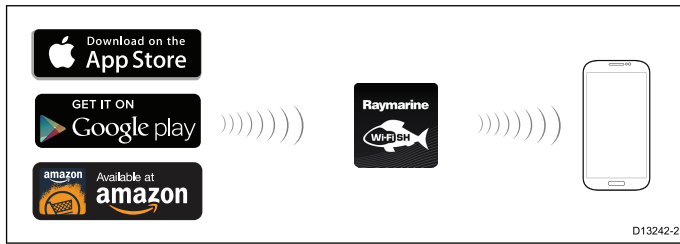

The **Wi-Fish™** app can be downloaded from the relevant app stores.

10.2 Connecting Wi-Fi — Pro displays

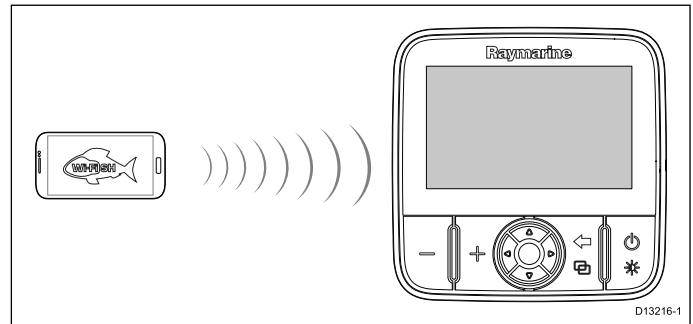

1. Install the **Wi-Fish™** app from the relevant app store.
2. Connect your smart device's Wi-Fi to the display. The product's network name, known as the SSID (Service Set Identifier) and Passphrase for your product can be found In the Wi-Fi settings menu and can be changed if desired: **Tools & Settings > WiFi Settings**.
3. Open the **Wi-Fish™** app.

Connecting your smart device

Your smart device's Wi-Fi connection must be connected to the product to enable use of the mobile **Wi-Fish™** app.

With the **Wi-Fish™** mobile app installed on your smart device:

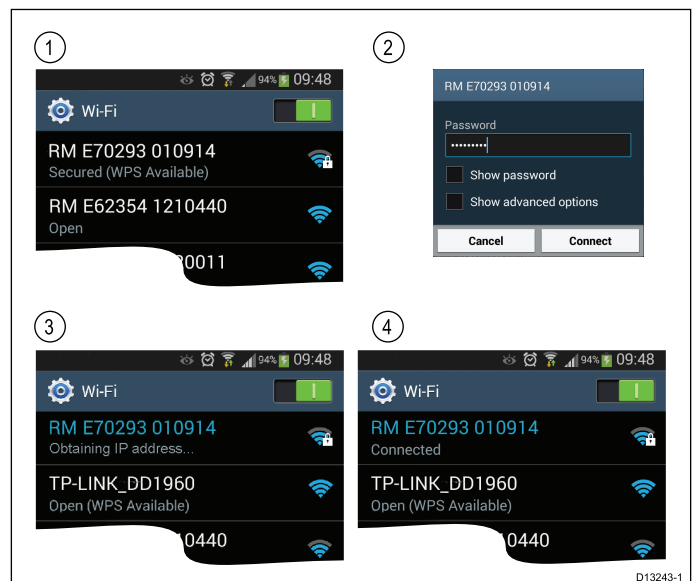

1. Open the Wi-Fi settings on your smart device and select your product's SSID from the list of available devices.
Your product's SSID can be found on the product label located on the bottom of the unit.
2. Enter your product passphrase.
Your product's passphrase can also be found on the product label located on the bottom of the unit.
3. Your device will now connect to the unit and obtain an IP address.
4. Once your device is connected you can open the **Wi-Fish™** app.

Chapter 11: Tools & Settings

Chapter contents

- [11.1 System Settings menu on page 96](#)
- [11.2 Alarms on page 102](#)
- [11.3 Backup and reset on page 105](#)
- [11.4 Wi-Fi Settings on page 107](#)

11.1 System Settings menu

The options available in the System settings menu are dependent on the display variant.

Menu item	Applicable displays	Description	Options
Alarms	<ul style="list-style-type: none"> DV 	You can configure the behavior of certain alarms by selecting the relevant menu option from the Alarms menu.	<ul style="list-style-type: none"> Deep water arrival Shallow water arrival Water temperature
Key Beep	<ul style="list-style-type: none"> DV DVS Pro 5 M 	An audible sound can be made each time a button is pressed.	<ul style="list-style-type: none"> On (default) Off
Language	<ul style="list-style-type: none"> DV DVS Pro 5 M 	Allows selection of the system language.	See the System Languages section for details.
Units Set-up	<ul style="list-style-type: none"> DV DVS Pro 5 M 	Allows selection of units of measurement that will be used in all applications.	<ul style="list-style-type: none"> * Distance Units * Speed Units Depth Units Temperature Units
GPS Set-up	<ul style="list-style-type: none"> Pro 5 M 	Provides GPS setting options.	<ul style="list-style-type: none"> View Satellite Status COG/SOG Filter: Restart GPS <div style="border: 1px solid black; padding: 5px; margin-top: 10px;"> <p>Note: * Only available on displays with an internal GPS / GNSS receiver.</p> </div>
Sonar Set-up	<ul style="list-style-type: none"> DV DVS Pro 	Provides sonar setting options.	<ul style="list-style-type: none"> Depth Offset (W) Sonar Reset
Waypoint Arrival Alarm	<ul style="list-style-type: none"> 5 M 	When you arrive at a waypoint, an alarm is triggered. This setting allows you to specify the distance from the target waypoint at which the alarm is triggered.	<ul style="list-style-type: none"> 0.01 nm to 9.99 nm (or equivalent units)
Time and Date Set-up	<ul style="list-style-type: none"> Pro 5 M 	Allows selection of date and time formats.	<ul style="list-style-type: none"> Date Format: Time Format: Local Time:
Simulator	<ul style="list-style-type: none"> DV DVS Pro 5 M 	Switches simulator mode On or Off.	<ul style="list-style-type: none"> Off (default) On On (Demo movie)
Backup & Reset	<ul style="list-style-type: none"> 5 M 	The Backup & Reset menu provides import, export and reset options.	See the 11.3 Backup and reset section for details.

Menu item	Applicable displays	Description	Options
Maintenance	<ul style="list-style-type: none"> • DV • DVS • Pro • 5 M 	Provides diagnostic information. Also enables you to reset the display to factory settings.	See the Maintenance menu section for details.
Bearing Mode	<ul style="list-style-type: none"> • Pro • 5 M 	Determines how bearing data is displayed.	<ul style="list-style-type: none"> • True • Magnetic (default)

Accessing the system settings menu

Depending on display variant, the **System Settings** menu can be accessed by:

- selecting **System Settings** from the **Tools & Settings** page (**DVS** and **Pro**), or by
- selecting: **Menu > System Settings** from the application menu (**DV** and **5 M**).

DV System settings menu options

The **System Settings** menu on the **DV** variant display is located in the main application menu.

Refer to [11.1 System Settings menu](#) for details on available options for your display variant.

5 M System settings menu

The **System Settings** menu on the **5 M** variant display is located in the main application menu.

Refer to [11.1 System Settings menu](#) for details on available options for your display variant.

System Languages

The system can operate in the following languages:

English (US)	English (UK)	Arabic
Bulgarian	Chinese	Croatian
Czech	Danish	Dutch
Finnish	French	German
Greek	Icelandic	Italian
Japanese	Korean	Norwegian
Polish	Portuguese (Brazilian)	Russian
Slovenian	Spanish	Swedish
Turkish		

Selecting a language

From the Tools & Settings menu:

1. Select **System Settings**.
2. Select **Language**:
3. Select the relevant language from the list.

Units set-up

You can specify your preference for the units of measurement that will be used in all applications.

Menu item	Description	Options
Distance Units	The units of measure that will be used in all applications for the display of all values related to distance.	<ul style="list-style-type: none"> Nautical Miles NM & m (Nautical miles and meters) Statute Miles Kilometers
Speed Units	The units of measure that will be used in all applications for the display of all values related to speed.	<ul style="list-style-type: none"> Knots MPH (Miles Per Hour) KPH (Kilometers Per Hour)
Depth Units	The units of measure that will be used in all applications for the display of all values related to depth.	<ul style="list-style-type: none"> Feet Meters Fathoms
Temperature Units	The units of measure that will be used in all applications for the display of all values related to temperature.	<ul style="list-style-type: none"> Fahrenheit Celsius

GPS Set-up menu

The options available from the GPS set-up menu are shown below.

Menu item	Description	Options
View Satellite Status	Displays the GPS status page.	
COG/SOG Filter:	Refer to the COG/SOG Filter section for details.	<ul style="list-style-type: none"> Low Medium (default) High
Restart GPS	Selecting Restart GPS will reboot the internal GPS.	

GPS Status

Products with an internal GPS receiver or GNSS (GPS/GLONASS) receiver can use the GPS status page to view the status of the available satellites that are compatible with your receiver.

The satellite constellations are used to position your boat in the Chart application. You can set up your receiver and check its status from the **GPS Set-up** menu. For each satellite, the screen provides the following information:

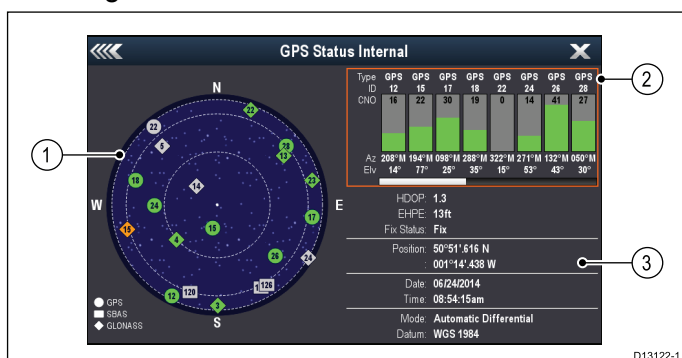

1. Sky view
2. Satellite status
3. Position and fix information

Sky view

Sky view is a visual representation that shows the position of navigation satellites and their type. Satellite types are:

- **Circle** — A circle identifies a satellite from the GPS constellation.
- **Square** — A square identifies an (SBAS) differential satellite.
- **Diamond** — A diamond identifies a satellite from the GLONASS constellation.

Satellite status area

The Satellite status area displays the following information about each satellite:

- **Type** — Identifies which constellation the satellite belongs to.
- **ID** — Displays the satellites identification number.
- **CNO** (Carrier-to-noise ratio) — Displays the signal strength of each satellite shown in the Sky view:
 - Grey = searching for satellite
 - Green = satellite in use
 - Orange = tracking satellite
- **Azimuth and Elevation** — Provides the angle of elevation and azimuth between the location of the receiver and the satellite.

Position and fix information

The following positional and fix information is provided:

- **Horizontal Dilution of Precision (HDOP)** — HDOP is a measure of satellite navigation accuracy, calculated from a number of factors including satellite geometry, system errors in the data transmission and system errors in the receiver. A higher figure signifies a greater positional error. A typical receiver has an accuracy of between 5 and 15 m. As an example, assuming a receiver error of 5 m, an HDOP of 2 would

represent an error of approximately 15 m. Please remember that even a very low HDOP figure is NO guarantee that your receiver is providing an accurate position. If in doubt, check the displayed vessel position in the Chart application against your actual proximity to a known charted object.

- **Estimated Horizontal Position Error (EHPE)** — EHPE is a measure of the estimated error of a position fix in the horizontal plane. The value displayed indicates that your position is within a circle radius of the stated size 50% of the time.
- **Fix status** — indicates the actual mode the receiver is reporting:
 - **Fix** — Satellite fix has been acquired.
 - **No Fix** — No satellite fix can be acquired.
 - **D Fix** — A differential beacon fix has been acquired.
 - **SD Fix** — A differential satellite fix has been acquired.
- **Position** — Displays the latitude and longitude position of your receiver.
- **Date / Time** — Displays the current date and time generated by the position fix in UTC format .
- **Mode** — Identifies whether the receiver is working in differential mode or non-differential mode.
- **Datum** — The receiver's datum setting affects the accuracy of the vessel position information displayed in the Chart application. In order for your receiver and MFD to correlate accurately with your paper charts, they must be using the same datum.

COG/SOG Filter

The COG/SOG filter averages the velocity vectors to compensate for the oscillating motion of the vessel, giving a clearer indication of the vessel’s course and speed.

The filter does not affect the calculation of your receiver’s reported position. The velocity vectors calculated from the signal provide an instantaneous measure of speed and direction of the receiver. The COG and SOG can therefore seem erratic under certain conditions. For example, when a vessel is moving slowly through rough seas, the receiver moves from side to side as well as in the direction of travel.

Slow moving vessels, or vessels sailing in rough seas will benefit from a high setting, whereas a power boat that can quickly change speed and direction will benefit from a low setting.

Sonar Set-up menu

The Sonar Set-up menu provides the following options.

Depth Offset:	Offset represents the depth of the transducer relative to: <ul style="list-style-type: none"> • Waterline = 0.0 ft and above. • Keel = 0.1 ft and below. 	<ul style="list-style-type: none"> • -9.8 to +9.8 feet — or equivalent units
Sonar Reset	Restore all settings on the sonar module to factory default. When performing a Sonar Reset , it is normal to briefly lose connection with the sonar module.	<ul style="list-style-type: none"> • Yes • No

Time and Date set-up

You can specify your preference for the way that time and date will appear in all applications.

Menu item	Description	Options
Date Format	Allows you to specify the preferred format for the display of date information in all applications.	<ul style="list-style-type: none">• MM:DD:YY (Month, Day, Year)• DD:MM:YY (Day, Month, Year)
Time Format	Allows you to specify the preferred format for the display of time information in all applications.	<ul style="list-style-type: none">• 12hr• 24hr
Local Time: UTC	Allows you to specify the local time zone that will be used, in terms of an offset from UTC (Universal Coordinated Time), in 0.5 hour increments.	<ul style="list-style-type: none">• -13 to +13 hours (in 0.5 hour increments)

Simulator mode

The Simulator mode enables you to practice operating your display without data from the GPS receiver or transducer.

The simulator mode is switched on / off in the **System Settings** menu.

Note: Raymarine recommends that you do NOT use the simulator mode whilst navigating.

Note: The simulator will NOT display any real data. This includes safety messages.

Enabling and disabling simulator mode

You can enable and disable simulator mode by following the steps below.

From the **System Settings** menu:

1. Select **Simulator**.
2. Select On to turn simulator mode on, or
3. Select Off to turn simulator mode off.

Note: The Demo movie option is for retail demonstration purposes only.

Maintenance menu

This menu provides access to systems settings reset and diagnostics.

Menu item	Description	Options
About This Unit	Displays a list of details about your unit.	<ul style="list-style-type: none">• Device• Serial No.• Software
Settings Reset	This option resets your menu options to factory default. It will NOT affect your waypoints or tracks.	<ul style="list-style-type: none">• Yes• No
Settings and Data Reset	In addition to the settings reset detailed above, performing a settings and data reset will also remove ALL waypoint and track data.	<ul style="list-style-type: none">• Yes• No
Back-up Settings	Back-up settings to a memory card.	
Restore Settings	Restore saved settings from a memory card.	
Save Logs	Allows you to save error logs to SD card for troubleshooting purposes.	
Erase Logs	Selecting this option will erase any crash logs on the device.	

11.2 Alarms

Alarms alert you to a situation or hazard requiring your attention.

You can configure the behavior of certain alarms by selecting the relevant menu option from the **Alarms** menu.

Accessing the alarms menu

Depending on display variant, the **Alarms** menu can be accessed by:

- selecting **Tools & Settings** from the View Switcher (**Dragonfly-4 Pro**, **Dragonfly-5 Pro**, and **Dragonfly-7**), or by
- selecting **System Settings** from the application menu (**Dragonfly-4 DV**, **Dragonfly-4 DVS**, **Dragonfly-5 DVS** and **Dragonfly-5 M**).

Alarms menu

The Alarms available are dependent on the display variant.

Alarm	Applicable displays	Description	Options
Deep Water Arrival	<ul style="list-style-type: none"> DV DVS Pro 	<p>When set to On, an alarm is triggered when the depth reaches the value specified in the Deep Limit setting. This option is only available when current depth data is available.</p> <div style="border: 1px solid black; padding: 5px;"> <p>Note: The Deep limit cannot be set to a value less than the Shallow Limit.</p> </div>	<p>Deep:</p> <ul style="list-style-type: none"> Off (default) On <p>Deep Limit:</p> <ul style="list-style-type: none"> 2 ft (or equivalent units) to the maximum of the transducer range
Shallow Water Arrival	<ul style="list-style-type: none"> DV DVS Pro 	<p>When set to On, an alarm is triggered when the depth reaches the value specified in the Shallow Limit setting. This option is only available when current depth data is available.</p> <div style="border: 1px solid black; padding: 5px;"> <p>Note: The Shallow Limit cannot be set to a depth greater than the Deep Limit.</p> </div>	<p>Shallow:</p> <ul style="list-style-type: none"> Off (default) On <p>Shallow Limit:</p> <ul style="list-style-type: none"> 2 ft (or equivalent units) to the maximum of the transducer range
Fish	<ul style="list-style-type: none"> DVS Pro 	<p>If the Fish alarm and fish depth limits alarm are set to On, a warning sound is triggered if any target meets the sensitivity level and is within the Shallow Fish Limit and Deep Fish Limit that you specify. The following items are available in the sub-menu:</p> <ul style="list-style-type: none"> Fish — Switches fish alarm On and Off. Fish Sensitivity — If the Fish alarm is set to On, an alarm is triggered when the fish return strength reaches the sensitivity that you specify. Fish Depth Limits — Switches depth limits On and Off. Shallow Fish Limit — Specifies the lower value for the Fish Alarm Depth Limit. Deep Fish Limit — Specifies the upper value for the Fish Alarm Depth Limit. 	<p>Fish</p> <ul style="list-style-type: none"> Off (default) On <p>Fish Sensitivity</p> <ul style="list-style-type: none"> 1 to 10 <p>Fish Depth Limits</p> <ul style="list-style-type: none"> On Off (default) <p>Shallow Fish Limit</p> <ul style="list-style-type: none"> 2 ft (or equivalent units) to the maximum of the transducer range <p>Deep Fish Limit</p> <ul style="list-style-type: none"> 2 ft (or equivalent units) to the maximum of the transducer range
Water Temperature	<ul style="list-style-type: none"> DVS Pro 	<p>When set to On, an alarm and pop-up message is triggered when the water temperature is equal to or lower than the Lower Temp Limit, or equal to or greater than the Upper Temp Limit.</p>	<p>Water Temperature</p> <ul style="list-style-type: none"> Off (default) On <p>Lower Temp Limit</p> <ul style="list-style-type: none"> 60 degrees fahrenheit (or equivalent units) -09.9 to +99.7 degrees fahrenheit (or equivalent units) <p>Upper Temp Limit</p>

Alarm	Applicable displays	Description	Options
			<ul style="list-style-type: none"> • 75 degrees fahrenheit (or equivalent units) • -09.7 to 99.9 degrees fahrenheit (or equivalent units)
Waypoint Arrival Alarm	<ul style="list-style-type: none"> • Pro 	When you arrive at a waypoint, an alarm is triggered. This setting allows you to specify the distance from the target waypoint at which the alarm is triggered.	0.01 to 9.99 nm (or equivalent units)

11.3 Backup and reset

The backup and reset menu provides the following functions:

Save Data to Card	Save waypoints and tracks to memory card.	For details on performing these procedures please refer to Saving user data and user settings .
Retrieve from Card	Retrieve / import waypoints and tracks from a memory card.	
Erase from Card	Erase files from a memory card.	
Erase from System	Erase waypoints and tracks from the system.	
User Settings	Backup, Reset and restore user settings, Reset settings and data.	
Restart GPS	Restart the internal GPS receiver.	
Sonar Reset	Reset the internal sonar module.	For details on performing a sonar reset please refer to Resetting your system

Accessing the backup & reset menu

Depending on display variant, the **Backup & Reset** menu can be accessed by:

- selecting **Backup & Reset** from the **Tools & Settings** page (**Pro** variants), or by
- selecting: **Menu > System settings > Backup & Reset** from the application menu (**5 M**).

Saving user data and user settings

You can save user data (waypoints and tracks) and user settings to a memory card for later retrieval.

Type of data	Description	Notes
Waypoints	Saves all waypoints to a single archive file.	Only 1 waypoints archive file can be saved per memory card.
Tracks	Saves all tracks to a single archive file.	Only 1 tracks archive file can be saved per memory card.
User settings	Saves settings you've made in the set-up menus to a single archive file.	Only 1 user settings archive file can be saved per memory card.

Note: It is recommended that you save your user data and user settings to a memory card on a regular basis.

Note: It is strongly recommended that you save user data and settings to a separate memory card, and NOT to a chart card containing cartography.

Erasing all waypoints from the system

Note: The following procedure permanently deletes all Waypoints from the display. BEFORE proceeding, ensure that you backup any data that you want to keep on to a MicroSD card.

From the **Backup & Reset** menu:

1. Select **Erase from System**.
2. Select **Erase Waypoints from System**.
A confirmation dialog is displayed.
3. Select **Yes** to confirm.

Erasing tracks from the system

Note: The following procedure permanently deletes the selected Tracks from the display. BEFORE proceeding, ensure that you backup any data that you want to keep on to a memory card.

From the Tools & Settings page:

1. Select **Backup & Reset**.
2. Select **Erase from System**.
3. Select **Erase Tracks from System**.
The Track list is displayed.
4. Select the Track that you want to delete, or
5. Select **Erase All**.
A confirmation dialog is displayed.
6. Select **Yes** to confirm.

Erasing waypoints and tracks from a MicroSD card

Ensure the MicroSD card with the saved waypoints and / or tracks that you want to delete is inserted into the card reader.

From the **Backup & Reset** menu:

1. Select **Erase from Card**.
The file browser is displayed.
2. Navigate to the file you want to delete.
3. Select the file you want to delete.
A confirmation dialog is displayed.
4. Select **Yes** to delete the file.

Saving user settings to a memory card

Ensure a memory card (NOT a chart card) is inserted into the card reader.

From the Tools & Settings page.

1. Select **Backup & Reset**.
2. Select **User Settings**.
3. Select **Back-up Settings**.
When complete a saving complete dialog box is displayed.
4. Select **OK** to acknowledge and return to normal operation, or
5. Select **Eject device** if you want to remove the memory card from the card reader.

Retrieving user settings from a memory card

Ensure the memory card with your user settings saved on it is inserted into the card reader.

From the Tools & Settings page.

1. Select **Backup & Reset**.
2. Select **User Settings**.
3. Select **Restore Settings**.
When complete a Restoring complete dialog box is displayed.
4. Select **OK** to acknowledge and return to normal operation, or
5. Select **Eject device** if you want to remove the memory card from the card reader.

Resetting your system

Your system may be reset to its factory default settings if required.

There are 3 types of reset operation.

- Settings reset.
- Settings and data reset.
- Sonar reset.

Settings reset

This option resets your setup menus to factory default. It will NOT affect your waypoints or tracks.

Settings and data reset

In addition to the settings reset detailed above, performing a settings and data reset will also remove ALL waypoints and tracks from the system.

Sonar reset

This option resets the sonar to default settings.

Resetting system settings

From the Tools & Settings page:

1. Select **Backup & Reset**.
2. Select **User Settings**.
3. Select **Settings Reset**.
A message is displayed prompting you to confirm the action.
4. Select **Yes** to proceed with the settings reset, or **No** to cancel.
If Yes is selected the system will reboot and the settings will be reset to factory defaults.

Resetting system settings and data

Note: Performing a settings and data reset erases ALL waypoints and tracks from your system. BEFORE proceeding with a settings and data reset, ensure that you backup any data that you want to keep on to a memory card.

From the Tools & Settings page:

1. Select **Backup & Reset**.
2. Select **User Settings**.
3. Select **Settings & Data Reset**.
A message is displayed prompting you to confirm the action.

4. Select **Yes** to proceed with the settings and data reset, or **No** to cancel.

If Yes is selected the system will reboot and the settings will be reset to factory defaults and all use data is deleted.

Resetting the sonar

The sonar setting can be reset to factory defaults.

From the Tools & Settings page:

1. Select **System Settings**.
2. Select **Sonar Set-up**.
3. Select **Sonar Reset**.
A confirmation dialog is displayed.
4. Select **Yes** to reset the sonar settings.

11.4 Wi-Fi Settings

Dragonfly® Pro variant displays include built-in Wi-Fi, that enables you to use the **Wi-Fish™** mobile app.

Note: These settings do not apply to the **Wi-Fish™** Wi-Fi Sonar module.

Menu item	Description	Options
Wi-Fi Name	The default Wi-Fi Name (SSID) can be changed to a more memorable name if required.	Onscreen keyboard is displayed.
Wi-Fi Passphrase	The default passphrase can be changed to a more memorable password.	Onscreen keyboard is displayed
Wi-Fi Channel	You can change the Wi-Fi channel to as less congested channel. Changing the Wi-Fi channel can help to resolve intermittent Wi-Fi connection issues.	<ul style="list-style-type: none"> • 1 to 11
Wi-Fi Security	<p>By default the recommended security type (WPA2 Only) is enabled. There should be no need to change the security type; however if your device does not support WPA2 then you can change the security type.</p> <div style="border: 1px solid black; padding: 5px; margin-top: 10px;"> <p>Note: It is not recommended that the Wi-Fi Security be set to None.</p> </div>	<ul style="list-style-type: none"> • None • WPA Only • WPA2 Only (default) • WPA/WPA2

Chapter 12: Maintenance

Chapter contents

- [12.1 Service and maintenance on page 110](#)
- [12.2 Product cleaning on page 110](#)
- [12.3 Transducer cleaning on page 111](#)

12.1 Service and maintenance

This product contains no user serviceable components. Please refer all maintenance and repair to authorized Raymarine dealers. Unauthorized repair may affect your warranty.

Routine equipment checks

Raymarine strongly recommends that you complete a number of routine checks to ensure the correct and reliable operation of your equipment.

Complete the following checks on a regular basis:

- Examine all cables for signs of damage or wear and tear.
- Check that all cables are securely connected.

12.2 Product cleaning

Best cleaning practices.

When cleaning products:

- If your product includes a display screen, do NOT wipe the screen with a dry cloth, as this could scratch the screen coating.
- Do NOT use abrasive, or acid or ammonia based products.
- Do NOT use a jet wash.

Cleaning the display case

The display unit is a sealed unit and does not require regular cleaning. If it is necessary to clean the unit, follow this basic procedure:

1. Switch off the power to the display.
2. Wipe the display with a clean, soft cloth (a microfibre cloth is ideal).
3. If necessary, use a mild detergent to remove grease marks.

Note: Do NOT use solvents or detergents on the screen itself.

Note: In certain conditions, condensation may appear inside the display screen. This will not harm the unit, and can be cleared by powering on the display for a short time.

Cleaning the display screen

A coating is applied to the display screen. This makes it water repellent, and prevents glare. To avoid damaging this coating, follow this procedure:

1. Switch off the power to the display.
2. Rinse the screen with fresh water to remove all dirt particles and salt deposits.
3. Allow the screen to dry naturally.
4. If any smears remain, very gently wipe the screen with a clean microfibre cleaning cloth (available from an opticians).

12.3 Transducer cleaning

Growth can collect on the bottom of the transducer, this can reduce performance. To prevent the build up of sea growth, coat the transducer with a thin layer of water based antifouling paint, available from your local marine dealer. Reapply paint every 6 months or at the beginning of each boating season. Certain smart transducers have restrictions on where antifouling paint is applied. Please consult your dealer.

Note: Transducers with a temperature sensor may not work properly if painted.

Note: Never use ketone based paint. Ketones can attack many plastics possibly damaging the sensor.

Note: Never use spray paint on your transducer. Spraying incorporates tiny air bubbles, and a marine transducer cannot transmit properly through air.

Use a soft cloth and mild household detergent to clean the transducer. If the fouling is severe, remove the growth with a green scotch brite™ pad. Be careful to avoid scratching the transducers face.

If your transducer has a paddlewheel you can wet sand with fine grade wet/dry paper.

Note: Harsh cleaning solvents such as acetone may damage the transducer.

Chapter 13: Troubleshooting

Chapter contents

- [13.1 Troubleshooting on page 114](#)
- [13.2 Power up troubleshooting on page 115](#)
- [13.3 GPS troubleshooting on page 116](#)
- [13.4 Sonar / DownVision troubleshooting on page 117](#)
- [13.5 Wi-Fi troubleshooting on page 119](#)
- [13.6 Miscellaneous troubleshooting on page 121](#)

13.1 Troubleshooting

The troubleshooting information provides possible causes and corrective action required for common problems associated with marine electronics installations.

All Raymarine products are, prior to packing and shipping, subjected to comprehensive test and quality assurance programs. However, if you experience problems with the operation of your product this section will help you to diagnose and correct problems in order to restore normal operation.

If after referring to this section you are still having problems with your unit, please contact Raymarine Technical Support for further advice.

13.2 Power up troubleshooting

Product does not turn on or keeps turning off

Possible causes	Possible solutions
Blown fuse / tripped breaker	<ol style="list-style-type: none"> 1. Check condition of relevant fuses and breakers and connections, replace if necessary (Refer to Chapter 15 Technical specification for fuse ratings.) 2. If fuse keeps blowing check for cable damage, broken connector pins or incorrect wiring.
Poor / damaged / insecure power supply cable / connections	<ol style="list-style-type: none"> 1. Check the unit's connector for broken or bent pins. 2. Check that the cable connector is fully inserted into the unit and that the locking collar is in the locked position. 3. Check the power supply cable and connectors for signs of damage or corrosion, replace if necessary. 4. With the unit turned on, try flexing the power cable near to the display connector to see if this causes the unit to re-boot/loose power, replace if necessary. 5. Check the vessel's battery voltage, the condition of the battery terminals and power supply cables, ensuring connections are secure, clean and free from corrosion, replace if necessary. 6. With the product under load, using a multi-meter, check for high voltage drop across all connectors/fuses etc (this can cause the Fishfinder applications to stop scrolling or the unit to reset/turn off), replace if necessary.
Incorrect power connection	The power supply may be wired incorrectly, ensure the installation instructions have been followed. (Refer to Chapter 5 Cables and connections for cable and connection requirements.)
Power source insufficient	With the product under load, using a multi-meter, check the power supply voltage as close to the unit as possible to establish actual voltage when the current is flowing. (Refer to Chapter 15 Technical specification for power supply requirements.)

Product will not boot up (re-boot loop)

Possible causes	Possible solutions
Power supply and connection	See possible solutions from 'Products does not turn on or keeps turning off' above.
Software corruption	<ol style="list-style-type: none"> 1. In the unlikely event that the products software has become corrupted please try re-flashing the latest software from the Raymarine website. 2. On display products, as a last resort, you can try to perform a 'Power on Reset', however this will delete all settings/presets and user data (such as waypoints and tracks) and revert the unit back to factory defaults.

Performing a Power on Reset

Performing a Power on Reset will delete all settings/presets and user data (such as waypoints and tracks) and revert the unit back to factory defaults.

1. Power the unit off.
2. Power the unit back on.
3. When the **Dragonfly** logo appears Press and hold the **Power** button.
The Raymarine Initialization screen is displayed.
4. Press the **Power** button again to select '1 – Reset to factory defaults'.

A 7 second countdown will begin. When the countdown reaches zero the unit will be reset to factory default settings.

5. You can stop the reset process by pressing the **Power** button again before the countdown timer reaches zero.
This will select the second option: '2– Exit and start the application' and begin a new countdown timer.

13.3 GPS troubleshooting

Before troubleshooting GPS problems ensure your product has the latest software, by checking the Software Updates page on the Raymarine website www.raymarine.com.

GPS cannot acquire satellite fix

Possible causes	Possible solutions
Geographic location or prevailing conditions preventing satellite fix.	Check periodically to see if a fix is obtained in better conditions or another geographic location. A GPS Status page is available. This provides satellite signal strength and other relevant information.
Location of product	For optimum performance the unit should be mounted above decks and not be in close proximity to any structural bulkheads or other electrical equipment or cables which may cause interference. Refer to Chapter 3 Planning the installation for details on product location requirements

Cannot output GPS data

Possible causes	Possible solutions
This product is a standalone product that is not networkable, GPS data cannot be shared with other devices.	N/A

13.4 Sonar / DownVision troubleshooting

Problems with the Sonar or DownVision and their possible causes and solutions are described here.

Scrolling image is not being displayed

Possible causes	Possible solutions
Sonar disabled	Select Enable Sonar from the Shortcuts page.
Damaged cables	<ol style="list-style-type: none"> 1. Check the unit's connector for broken or bent pins. 2. Check that the cable connector is fully inserted into the unit and that the locking collar is in the locked position. 3. Check the power supply cable and connectors for signs of damage or corrosion, replace if necessary. 4. With the unit turned on, try flexing the power cable near to the display connector to see if this causes the unit to re-boot/loose power, replace if necessary. 5. Check the vessel's battery voltage, the condition of the battery terminals and power supply cables, ensuring connections are secure, clean and free from corrosion, replace if necessary. 6. With the product under load, using a multi-meter, check for high voltage drop across all connectors/fuses etc (this can cause the Fishfinder applications to stop scrolling or the unit to reset/turn off), replace if necessary.
Damaged or fouled transducer	Check the condition of the transducer ensuring it is not damaged and is free from debris/fouling, clean or replace as necessary.
Wrong transducer fitted	The CPT-DV transducer is a DownVision™ only transducer, you cannot use the Sonar application with a CPT-DV transducer connected. If you have a DVS or Pro variant display ensure you are using a dual element transducer such as the CPT-DVS . Refer to 3.5 DownVision™ transducer compatibility for transducer compatibility.

No depth reading / lost bottom lock

Possible causes	Possible solutions
Transducer location	Check that the transducer has been installed in accordance with the transducer location requirements (refer to 3.10 Selecting a location for the transducer of the manual for details).
Transducer angle	If the transducer angle is too great the beam can miss the bottom, adjust transducer angle and recheck.
Transducer kicked-up	Check that the transducer hasn't kicked up due to hitting an object.
Power source insufficient	With the product under load, using a multi-meter, check the power supply voltage as close to the unit as possible to establish actual voltage when the current is flowing. (Refer to Chapter 15 Technical specification for power supply requirements.)
Damaged or fouled transducer	Check the condition of the transducer ensuring it is not damaged and is free from debris / fouling.
Damaged cables	<ol style="list-style-type: none"> 1. Check the unit's connector for broken or bent pins. 2. Check that the cable connector is fully inserted into the unit and that the locking collar is in the locked position. 3. Check the power supply cable and connectors for signs of damage or corrosion, replace if necessary. 4. With the unit turned on, try flexing the power cable near to the display connector to see if this causes the unit to re-boot/loose power, replace if necessary. 5. Check the vessel's battery voltage, the condition of the battery terminals and power supply cables, ensuring connections are secure, clean and free from corrosion, replace if necessary.

Possible causes	Possible solutions
	6. With the product under load, using a multi-meter, check for high voltage drop across all connectors/fuses etc (this can cause the Fishfinder applications to stop scrolling or the unit to reset/turn off), replace if necessary.
Vessel speed too high	Slow vessel speed and recheck. Note: The Sonar channel will be able to hold bottom at higher speeds than the DownVision™ channel.
Bottom too shallow or too deep	The bottom depth may be outside of the transducers depth range, move vessel to shallower or deeper waters as relevant and recheck. (Refer to Chapter 15 Technical specification for transducer depth range.) Note: Depending on water conditions, the Sonar channel maybe able to achieve increased depth range over the DownVision™ channel.

Poor / problematic image

Possible causes	Possible solutions
Scrolling paused	From Cursor mode, press the Back button to enter scrolling mode.
Sensitivity settings may be inappropriate for present conditions.	Check and adjust sensitivity settings or perform a Sonar reset.
Damaged cables	<ol style="list-style-type: none"> 1. Check the unit's connector for broken or bent pins. 2. Check that the cable connector is fully inserted into the unit and that the locking collar is in the locked position. 3. Check the power supply cable and connectors for signs of damage or corrosion, replace if necessary. 4. With the unit turned on, try flexing the power cable near to the display connector to see if this causes the unit to re-boot/loose power, replace if necessary. 5. Check the vessel's battery voltage, the condition of the battery terminals and power supply cables, ensuring connections are secure, clean and free from corrosion, replace if necessary. 6. With the product under load, using a multi-meter, check for high voltage drop across all connectors/fuses etc (this can cause the Fishfinder applications to stop scrolling or the unit to reset/turn off), replace if necessary.
Transducer location	<p>The presence of thin lines at a constant depth may be a reflection of structures on the bottom of the vessel check that the transducer has been installed in accordance with the transducer location requirements (refer to 3.10 Selecting a location for the transducer of the manual for details).</p> <p>If the transducer is mounted too high on the transom it may be lifting out of the water, check that the transducer face is fully submerged when planing and turning.</p>
Transducer kicked-up	Check that the transducer hasn't kicked up due to hitting an object.
Damaged or fouled transducer	Check the condition of the transducer ensuring it is not damaged and is free from debris / fouling.
Damaged transducer cable	Check that the transducer cable and connection is free from damage and that the connections are secure and free from corrosion.
Turbulence around the transducer at higher speeds may affect transducer performance	Slow vessel speed and recheck.
Interference from another transducer	<ol style="list-style-type: none"> 1. Turn off the transducer causing the interference. 2. Reposition the transducers so they are further apart.

13.5 Wi-Fi troubleshooting

Before troubleshooting problems with your Wi-Fi connection, ensure that you have followed the Wi-Fi location requirements guidance provided in the relevant installation instructions and performed a power cycle/reboot of the devices you are experiencing problems with.

Cannot find network

Possible cause	Possible solutions
Wi-Fi not currently enabled on devices.	Ensure Wi-Fi is enabled on both Wi-Fi devices and rescan available networks.
Some devices may automatically turn off Wi-Fi when not in use to save power.	Power cycle / reboot devices and rescan available networks.
Device not broadcasting.	<ol style="list-style-type: none"> 1. Try to enable broadcasting of the device's network using the Wi-Fi settings on the device you are trying to connect to. 2. You may still be able to connect to the device, when it is not broadcasting, by manually entering the device's Wi-Fi Name / SSID and passphrase in the connection settings of the device you are trying to connect.
Devices out of range or signal being blocked.	Move devices closer together or, if possible remove the obstructions and then rescan available network.

Cannot connect to network

Possible cause	Possible solutions
Some devices may automatically turn off Wi-Fi when not in use to save power.	Power cycle/reboot devices and retry the connection.
Trying to connect to the wrong Wi-Fi network	Ensure you are trying to connect to the correct Wi-Fi network, the Wi-Fi network's name can be found in the Wi-Fi settings on the broadcasting device (the device that you are trying to connect to).
Incorrect network credentials	Ensure you are using the correct passphrase, the Wi-Fi network's passphrase can be found in the Wi-Fi settings on the broadcasting device (the device that you are trying to connect to).

Possible cause	Possible solutions
Bulkheads, decks and other heavy structure can degrade and even block the Wi-Fi signal. Depending on the thickness and material used it may not always be possible to pass a Wi-Fi signal through certain structures	<ol style="list-style-type: none"> 1. Try repositioning the devices so the structure is removed from the direct line of sight between the devices, or 2. If possible use a wired connection instead.
Interference being caused by other Wi-Fi enabled or older Bluetooth enabled devices (Bluetooth and Wi-Fi both operate in the 2.4 GHz frequency range, some older bluetooth devices may interfere with Wi-Fi signals.)	<ol style="list-style-type: none"> 1. Change the Wi-Fi Channel of the device you are trying to connect to and retry the connection. You can use free Wi-Fi analyzer apps on your smart device to help you choose a better channel (channel with least traffic). 2. Temporarily disable each wireless device in turn until you have identified the device causing the interference.
Interference caused by other devices that use the 2.4GHz frequency See list below of some common devices that use the 2.4GHz frequency: <ul style="list-style-type: none"> • Microwave ovens • Fluorescent lighting • Cordless phones / baby monitors • Motion sensors 	Temporarily switch off each device in turn until you have identified the device causing the interference, then remove or reposition the offending device(s).
Interference caused by electrical and electronic devices and associated cabling could generate an electromagnetic field which may interfere with the Wi-Fi signal.	Temporarily switch off each item in turn until you have identified the device causing the interference, then remove or reposition the offending device(s).

Connection extremely slow and or keeps dropping out

Possible cause	Possible solutions
Wi-Fi performance degrades over distance so products farther away will receive less network bandwidth. Products installed close to their maximum Wi-Fi range will experience slow connection speeds, signal drop outs or not being able to connect at all.	<ul style="list-style-type: none"> • Move devices closer together. • For fixed installations such as a Quantum Radar, enable the Wi-Fi connection on an MFD installed closer to the device.
Interference being caused by other Wi-Fi enabled or older Bluetooth enabled devices (Bluetooth and Wi-Fi both operate in the 2.4 GHz frequency range, some older bluetooth devices may interfere with Wi-Fi signals.)	<ol style="list-style-type: none"> 1. Change the Wi-Fi Channel of the device you are trying to connect to and retry the connection. You can use free Wi-Fi analyzer apps on your smart device to help you choose a better channel (channel with least traffic). 2. Temporarily switch off each device in turn until you have identified the device causing the interference, then remove or reposition the offending device(s).
Interference from devices on other vessels. When in close proximity to other vessels, for example, when moored up in a marina, many other Wi-Fi signals may be present.	<ol style="list-style-type: none"> 1. Change the Wi-Fi Channel of the device you are trying to connect to and retry the connection. You can use free Wi-Fi analyzer apps on your smart device to help you choose a better channel (channel with least traffic). 2. If possible, move your vessel to a location with less Wi-Fi traffic.

Mobile application running slowly or not at all

Possible cause	Possible solutions
Raymarine app not installed	Install mobile app from relevant app store.
Raymarine app version not compatible with MFD software	Ensure mobile app and MFD software are latest available versions.
Mobile apps not enabled on MFD	Enable "Viewing only" or "Remote Control" as required in the Mobile Apps setting on your MFD.

Network connection established but no data

Possible cause	Possible solutions
Connected to the wrong network.	Ensure that your devices is connected to the correct network.
Device software incompatibility	Ensure both devices are running the latest available software.
It may be possible that the device has become defective	<ol style="list-style-type: none"> 1. Try updating software to a later version, or 2. try reinstalling the software. 3. Obtain new replacement device.

13.6 Miscellaneous troubleshooting

Miscellaneous problems and their possible causes and solutions are described here.

Problem	Possible causes	Possible solutions
Display behaves erratically: <ul style="list-style-type: none"> • Frequent unexpected resets. • System crashes or other erratic behavior. 	Intermittent problem with power to the display.	Check relevant fuses and breakers.
		Check that the power supply cable is sound and that all connections are tight and free from corrosion.
		Check that the power source is of the correct voltage and sufficient current.
	Ensure you have the latest software.	Check the Raymarine website regularly for software updates for your product www.raymarine.com .
Corrupt data / other unknown issue.	Perform a Settings and Data Reset. <div style="border: 1px solid black; padding: 5px; margin-top: 10px;"> <p>Important: This will result in the loss of any settings and data (such as waypoints) stored on the product. Save any important data to a memory card before resetting.</p> </div>	

Chapter 14: Technical support

Chapter contents

- [14.1 Raymarine product support and servicing on page 124](#)
- [14.2 Learning resources on page 125](#)

14.1 Raymarine product support and servicing

Raymarine provides a comprehensive product support service, as well as warranty, service, and repairs. You can access these services through the Raymarine website, telephone, and e-mail.

Product information

If you need to request service or support, please have the following information to hand:

- Product name.
- Product identity.
- Serial number.
- Software application version.
- System diagrams.

You can obtain this product information using the menus within your product.

Servicing and warranty

Raymarine offers dedicated service departments for warranty, service, and repairs.

Don't forget to visit the Raymarine website to register your product for extended warranty benefits: <http://www.raymarine.co.uk/display/?id=788>.

Region	Tele- phone	E-mail
United Kingdom (UK), EMEA, and Asia Pacific	+44 (0)1329 246 932	emea.service@raymarine.com
United States (US)	+1 (603) 324 7900	rm-usrepair@flir.com

Web support

Please visit the "Support" area of the Raymarine website for:

- **Manuals and Documents** — <http://www.raymarine.co.uk/display/?id=10125>
- **FAQ / Knowledgebase** — <http://www.raymarine.co.uk/knowledgebase/>
- **Technical support forum** — <http://raymarine.ning.com/>
- **Software updates** — <http://www.raymarine.com/software>

Telephone and e-mail support

Region	Tele- phone	E-mail
United Kingdom (UK), EMEA, and Asia Pacific	+44 (0)1329 246 777	support.uk@raymarine.com
United States (US)	+1 (603) 324 7900 (Toll-free: +800 539 5539)	support@raymarine.com

Region	Tele- phone	E-mail
Australia and New Zealand	+61 2 8977 0300	aus.support@raymarine.com (Raymarine subsidiary)
France	+33 (0)1 46 49 72 30	support.fr@raymarine.com (Raymarine subsidiary)
Germany	+49 (0)40 237 808 0	support.de@raymarine.com (Raymarine subsidiary)
Italy	+39 02 9945 1001	support.it@raymarine.com (Raymarine subsidiary)
Spain	+34 96 2965 102	sat@azimut.es (Authorized Raymarine distributor)
Netherlands	+31 (0)26 3614 905	support.nl@raymarine.com (Raymarine subsidiary)
Sweden	+46 (0)317 633 670	support.se@raymarine.com (Raymarine subsidiary)
Finland	+358 (0)207 619 937	support.fi@raymarine.com (Raymarine subsidiary)
Norway	+47 692 64 600	support.no@raymarine.com (Raymarine subsidiary)
Denmark	+45 437 164 64	support.dk@raymarine.com (Raymarine subsidiary)
Russia	+7 495 788 0508	info@mikstmarine.ru (Authorized Raymarine distributor)

14.2 Learning resources

Raymarine has produced a range of learning resources to help you get the most out of your products.

Video tutorials

	<p>Raymarine official channel on YouTube:</p> <ul style="list-style-type: none">• http://www.youtube.com/user/RaymarineInc
	<p>Video Gallery:</p> <ul style="list-style-type: none">• http://www.raymarine.co.uk/view/?id=2679
	<p>Product Support videos:</p> <ul style="list-style-type: none">• http://www.raymarine.co.uk/view/?id=4952

Note:

- Viewing the videos requires a device with an Internet connection.
- Some videos are only available in English.

Training courses

Raymarine regularly runs a range of in-depth training courses to help you make the most of your products. Visit the Training section of the Raymarine website for more information:

- <http://www.raymarine.co.uk/view/?id=2372>

FAQs and Knowledge Base

Raymarine has produced an extensive set of FAQs and a Knowledge Base to help you find more information and troubleshoot any issues.

- <http://www.raymarine.co.uk/knowledgebase/>

Technical support forum

You can use the Technical support forum to ask a technical question about a Raymarine product or to find out how other customers are using their Raymarine equipment. The resource is regularly updated with contributions from Raymarine customers and staff:

- <http://raymarine.ning.com/>

Chapter 15: Technical specification

Chapter contents

- [15.1 Technical specification — Dragonfly-4 on page 128](#)
- [15.2 Technical specification — Dragonfly-5 on page 129](#)
- [15.3 Technical specification — Dragonfly-7 on page 130](#)
- [15.4 Technical specification — Wi-Fish™ on page 131](#)
- [15.5 Technical specification — CPT-DV and CPT-DVS on page 131](#)

15.1 Technical specification — Dragonfly-4

Physical specification — Dragonfly-4

Dimensions	<ul style="list-style-type: none"> • Display Width: 145 mm (5.7 in) • Display Height: 145 mm (5.7 in) • Display depth (NOT including cables): 56 mm (2.2 in) • Display depth (including cables): 146 mm (5.7 in)
Weight (unit including bracket)	0.54 Kg (1.18 lbs)

Power specification — Dragonfly-4

Nominal supply voltage	12 V dc
Operating voltage range	10.8 V dc to 15.6 V dc
Power consumption at full brightness	<ul style="list-style-type: none"> • DV – 3 W RMS • DVS – 3.9 W RMS • Pro – 4.3 W RMS
Power consumption in PowerSave mode	<ul style="list-style-type: none"> • DV – 2.2 W RMS • DVS – 3.2 W RMS • Pro – 3.5 W RMS
Fuse and thermal breaker ratings	<ul style="list-style-type: none"> • 2 A — Slow blow In-line fuse (not supplied) • 3 A — Thermal breaker

Display LCD specification — Dragonfly-4

Size	4.3 in
Type	TFT backlit LED
Color depth	24-bit
Resolution	480 x 272 WQVGA
Aspect	16:9
Viewing angle	<ul style="list-style-type: none"> • Left / Right: 70 degrees • Top / Bottom: 50 / 70 degrees
Maximum allowable wrongly illuminated pixels	5

Display environmental specification

Environmental specifications below apply to all display variants

Operating temperature	0 °C to +55 °C (32 °F to 131 °F)
Storage temperature	-30 °C to +70 °C (-22 °F to 158 °F)

Relative humidity	Maximum 75%
Waterproof rating	• IPX6 and IPX7

Sonar / DownVision™ specification

The following specification only applies to DownVision™ products.

Channels	2 x CHIRP (1 x traditional sonar and 1 x DownVision™)
Beam coverage	<ul style="list-style-type: none"> • Sonar — conical beam. • DownVision™ — Wide (port / starboard) and thin (fore / aft) fan beam.
Depth range	0.6 M (2 ft) to 183 m (600 ft). Depending on water conditions, the Sonar channel maybe able to achieve increased depth range over the DownVision™ channel.

Note: The DV and Wi-Fish™ variants are single channel DownVision™ only products.

Internal GNSS (GPS / GLONASS) receiver specification

The following specification applies to the Pro and M variants of Dragonfly® products.

Channels	72
Cold start	<2 minutes
Receiver IC Sensitivity	-167 dBm (Tracking) / -148 dBm (Acquisition)
GNSS compatibility	<ul style="list-style-type: none"> • GPS • GLONASS
SBAS compatibility	<ul style="list-style-type: none"> • WAAS • EGNOS • MSAS
Special features	Active Jamming and Interference Reduction
Operating frequency	<ul style="list-style-type: none"> • GPS L1 C/A • GLONASS L10F
Signal Acquisition	Automatic
Almanac Update	Automatic
Geodetic Datum	WGS-84 (alternatives available through GPS Setup options)
Refresh Rate	10 Hz (10 times per second Concurrent GNSS)
Antenna	<ul style="list-style-type: none"> • Internal — Ceramic chip mounted near top of unit
Position Accuracy	<ul style="list-style-type: none"> • Without SBAS: <= 15 metres 95% of the time • With SBAS: <= 5 metres 95% of the time

15.2 Technical specification — Dragonfly-5

Physical specification — Dragonfly-5

Dimensions	<ul style="list-style-type: none"> • Display Width: 145 mm (5.7 in) • Display Height: 145 mm (5.7 in) • Display depth (NOT including cables): 56 mm (2.2 in) • Display depth (including cables): 146 mm (5.7 in)
Weight (unit including bracket)	0.57 kg (1.25 lbs)

Power specification — Dragonfly-5

Nominal supply voltage	12 V dc
Operating voltage range	10.8 V dc to 15.6 V dc
Power consumption at full brightness	<ul style="list-style-type: none"> • DVS – 4.7 W RMS • M – 2.9 W RMS • Pro – 5.3 W RMS
Power consumption in PowerSave mode	<ul style="list-style-type: none"> • DVS – 3.5 W RMS • M – 1.4 W RMS • Pro – 4 W RMS
Fuse and thermal breaker ratings	<ul style="list-style-type: none"> • 2 A — Slow blow In-line fuse (not supplied) • 3 A — Thermal breaker

Display LCD specification — Dragonfly-5

Size	5 in
Type	TFT backlit LED
Color depth	24-bit
Resolution	800 x 480 WVGA
Aspect	15:9
Viewing angle	<ul style="list-style-type: none"> • Left / Right: 75 degrees • Top / Bottom: 60 / 70 degrees
Maximum allowable wrongly illuminated pixels	7

Display environmental specification

Environmental specifications below apply to all display variants

Operating temperature	0 °C to +55 °C (32 °F to 131 °F)
Storage temperature	-30 °C to +70 °C (-22 °F to 158 °F)

Relative humidity	Maximum 75%
Waterproof rating	• IPX6 and IPX7

Sonar / DownVision™ specification

The following specification only applies to **DownVision™** products.

Channels	2 x CHIRP (1 x traditional sonar and 1 x DownVision™)
Beam coverage	<ul style="list-style-type: none"> • Sonar — conical beam. • DownVision™ — Wide (port / starboard) and thin (fore / aft) fan beam.
Depth range	0.6 M (2 ft) to 183 m (600 ft). Depending on water conditions, the Sonar channel maybe able to achieve increased depth range over the DownVision™ channel.

Note: The **DV** and **Wi-Fish™** variants are single channel **DownVision™** only products.

Internal GNSS (GPS / GLONASS) receiver specification

The following specification applies to the **Pro** and **M** variants of **Dragonfly®** products.

Channels	72
Cold start	<2 minutes
Receiver IC Sensitivity	-167 dBm (Tracking) / -148 dBm (Acquisition)
GNSS compatibility	<ul style="list-style-type: none"> • GPS • GLONASS
SBAS compatibility	<ul style="list-style-type: none"> • WAAS • EGNOS • MSAS
Special features	Active Jamming and Interference Reduction
Operating frequency	<ul style="list-style-type: none"> • GPS L1 C/A • GLONASS L10F
Signal Acquisition	Automatic
Almanac Update	Automatic
Geodetic Datum	WGS-84 (alternatives available through GPS Setup options)
Refresh Rate	10 Hz (10 times per second Concurrent GNSS)
Antenna	<ul style="list-style-type: none"> • Internal — Ceramic chip mounted near top of unit
Position Accuracy	<ul style="list-style-type: none"> • Without SBAS: <= 15 metres 95% of the time • With SBAS: <= 5 metres 95% of the time

15.3 Technical specification — Dragonfly-7

Physical specification — Dragonfly-7

Dimensions	<ul style="list-style-type: none"> • Display Width: 199 mm (7.83 in) • Display Height: 178 mm (7 in) • Display depth (NOT including cables): 62.2 mm (2.45 in) • Display depth (including cables): 152.2 mm (5.99 in)
Weight (unit including bracket)	0.922 kg (2 lbs)

Power specification — Dragonfly-7

Nominal supply voltage	12 V dc
Operating voltage range	10.8 V dc to 15.6 V dc
Power consumption at full brightness	<ul style="list-style-type: none"> • 9 W RMS
Power consumption in PowerSave mode	<ul style="list-style-type: none"> • 4 W RMS
Fuse and thermal breaker ratings	<ul style="list-style-type: none"> • 3 A — Slow blow In-line fuse (not supplied) • 4 A — Thermal breaker

Display LCD specification — Dragonfly-7

Size	7 in
Type	TFT backlit LED
Color depth	24-bit
Resolution	800 x 480 WVGA
Aspect	15:9
Viewing angle	<ul style="list-style-type: none"> • Left / Right: 60 degrees • Top / Bottom: 60 / 40 degrees
Maximum allowable wrongly illuminated pixels	5

Display environmental specification

Environmental specifications below apply to all display variants

Operating temperature	0 °C to +55 °C (32 °F to 131 °F)
Storage temperature	-30 °C to +70 °C (-22 °F to 158 °F)
Relative humidity	Maximum 75%
Waterproof rating	<ul style="list-style-type: none"> • IPX6 and IPX7

Sonar / DownVision™ specification

Channels	<ul style="list-style-type: none"> • DV / DVS / Pro / Wi-Fish™ — 1 x DownVision™ channel • DVS / Pro — 1 x CHIRP sonar channel
Beam coverage	<ul style="list-style-type: none"> • CHIRP Sonar — conical beam. • DownVision™ — Wide (port / starboard) and thin (fore / aft) fan beam.
Depth range	0.6 M (2 ft) to 183 m (600 ft). Depending on water conditions, the Sonar channel maybe able to achieve increased depth range over the DownVision™ channel.

Internal GNSS (GPS / GLONASS) receiver specification

The following specification applies to the **Pro** and **M** variants of **Dragonfly®** products.

Channels	72
Cold start	<2 minutes
Receiver IC Sensitivity	-167 dBm (Tracking) / -148 dBm (Acquisition)
GNSS compatibility	<ul style="list-style-type: none"> • GPS • GLONASS
SBAS compatibility	<ul style="list-style-type: none"> • WAAS • EGNOS • MSAS
Special features	Active Jamming and Interference Reduction
Operating frequency	<ul style="list-style-type: none"> • GPS L1 C/A • GLONASS L10F
Signal Acquisition	Automatic
Almanac Update	Automatic
Geodetic Datum	WGS-84 (alternatives available through GPS Setup options)
Refresh Rate	10 Hz (10 times per second Concurrent GNSS)
Antenna	<ul style="list-style-type: none"> • Internal — Ceramic chip mounted near top of unit
Position Accuracy	<ul style="list-style-type: none"> • Without SBAS: <= 15 metres 95% of the time • With SBAS: <= 5 metres 95% of the time

15.4 Technical specification — Wi-Fish™

Physical specification — Wi-Fish™

Dimensions	<ul style="list-style-type: none"> • Display Width: 145 mm (5.7 in) • Display Height: 145 mm (5.7 in) • Display depth (NOT including cables): 56 mm (2.2 in) • Display depth (including cables): 146 mm (5.7 in)
Weight (unit including bracket)	0.42 kg (0.92 lbs)

Power specification — Wi-Fish™

Nominal supply voltage	12 V dc
Operating voltage range	10.8 V dc to 15.6 V dc
Power consumption at full brightness	• 2.7 W RMS
Power consumption in PowerSave mode	• N/A
Fuse and thermal breaker ratings	<ul style="list-style-type: none"> • 2 A — Slow blow In-line fuse (not supplied) • 3 A — Thermal breaker

Display environmental specification

Environmental specifications below apply to all display variants

Operating temperature	0 °C to +55 °C (32 °F to 131 °F)
Storage temperature	-30 °C to +70 °C (-22 °F to 158 °F)
Relative humidity	Maximum 75%
Waterproof rating	• IPX6 and IPX7

Sonar / DownVision™ specification

The following specification only applies to DownVision™ products.

Channels	2 x CHIRP (1 x traditional sonar and 1 x DownVision™)
Beam coverage	<ul style="list-style-type: none"> • Sonar — conical beam. • DownVision™ — Wide (port / starboard) and thin (fore / aft) fan beam.
Depth range	0.6 M (2 ft) to 183 m (600 ft). Depending on water conditions, the Sonar channel maybe able to achieve increased depth range over the DownVision™ channel.

Note: The DV and Wi-Fish™ variants are single channel DownVision™ only products.

15.5 Technical specification — CPT-DV and CPT-DVS

Physical specification — CPT-DV / CPT-DVS Transducer

Dimensions	<ul style="list-style-type: none"> • Length: 228 mm (8.97 in) • Height: 111.2 mm (4.4 in)
Cable length	<ul style="list-style-type: none"> • CPT-DV — 4 m (13.1 ft) • CPT-DVS — 6 m (19.7 ft)
Weight (including cable)	0.437 kg (0.96 lbs)

Transducer environmental specification

Operating temperature	0 °C to + 40 °C (32 °F to 104 °F)
Storage temperature	-20 °C to + 70 °C (23 °F to 158 °F)
Waterproof rating	• IPX6 and IPX7

Chapter 16: Spares and accessories

Chapter contents

- [16.1 Spares & Accessories on page 134](#)

16.1 Spares & Accessories

Accessories

Description	Part numbers
Dragonfly-4 and Dragonfly-5 Surface mount adaptor kit	A80366
Dragonfly-7 Surface mount adaptor kit	A80347
Dragonfly-4 and Dragonfly-5 Suncover	A80367
Dragonfly-7 Suncover	A80348
Trolling motor / under hull bracket	A80330
4 m (13.1 ft) transducer / power extension cable	A80312
CPT-DV / CPT-DVS (3 keyway) to Legacy Dragonfly-6 / Dragonfly-7 (1 keyway) adaptor cable	A80331
Legacy (1 keyway) CPT-60 / CPT-70/ CPT-80 transducer to Dragonfly-4 / Dragonfly-5 and Wi-Fish™ (3 keyway) adaptor cable	A80332

Spares

Description	Part numbers
Display mounting bracket	R70375
CPT-DV / CPT-DVS transom mount bracket	R70439
Dragonfly-5 M 1.5 m (4.9 ft) power cable	R70376
CPT-DV transducer	R70373
CPT-DVS transducer	R70374

Raymarine[®]
BY  **FLIR**[®]



www.raymarine.com

CE 0168 